

使用說明書 INSTRUCTION MANUAL

HITACHI
Inspire the Next

日立多門電冰箱

REFRIGERATOR-FREEZER

家庭用 For home use

型號 Model R-HWS480KH R-HWS480KHL
R-HWS480KS



日本製
Made in Japan

五門 5 doors

除了門鉸鏈位置，左右鉸鏈型號相同。
Both of R- & L-hinge model are identical except location of door hinges.

非常感謝您購買日立電冰箱。
此電冰箱僅供家庭使用，請勿用於商業行為或儲存食品以外的其他目的。
請詳閱本使用說明書，以確保正確使用。使用前請務必詳閱「安全上之注意事項」。
請妥善保管本使用說明書與保證書。如將電冰箱交給他人或在別的場所使用或者交給回收工廠，請將本使用說明書隨電冰箱一同轉交。

Thank you for purchasing a Hitachi refrigerator. This refrigerator is designed for home use only. Do not use this refrigerator for commercial use or for any purpose other than storing food. Please read this manual to ensure correct usage and safety. Please keep this manual, together with your warranty, in a safe place. If you hand this refrigerator over to another party, pass on this manual as well.

● 購買後初次使用時。 (→P.8, 9)

初次使用時，完全冷卻可能至少需要約 4 至 24 小時。

● 存放食物時，請勿超過各存儲隔的高度限制，並確保食品の間隙。 (→P.18, 20)

存放過多的食物，食物或包裝可能無法妥善放置。如果電冰箱門關閉不緊，可能導致製冷效率低，不能製冰等後果。

● When plugged in for the first time, the refrigerator takes about 4 to 24 hours to completely cool. (→P.42, 43)

● For optimal cooling, store items in the appropriate compartments according to the guidelines in this manual and leave space between items. (→P.52, 54)

節省能源的使用方法

Energy-saving tips

1. 減少冰箱門的開閉，且開門時間切勿過長

開閉次數多，冷氣向外流失，保冷效果差。

2. 切勿塞滿過多的食物

如果塞滿過多的食物，冷氣循環不良，不僅無法讓冰箱內均一冷卻，而且還會消耗電力。存放食物時請保留適度的間隙。

3. 將熱的食物放冷之後再放入冰箱

如果將熱的食物放入冰箱，冰箱內部的溫度升高，周邊食物的溫度也會隨之升高。

4. 冰箱周邊應保留適當的間隙

如果周邊不留間隙，冰箱將無法散熱，造成電力浪費。

5. 更換受損的冰箱門墊圈

墊圈受損後所產生的間隙可使冷氣流失，造成電力浪費。如要檢查墊圈是否受損，可將名片等夾在冰箱門之間，如果名片滑落，說明冰箱門無法夾緊，請更換墊圈。

1. Minimize how frequently you open refrigerator doors and how long doors are kept open.

2. Do not store too much food in the refrigerator. Leave space between items in the refrigerator.

Storing too much food in the refrigerator prevents the circulation of cold air, leading to uneven cooling and increased energy consumption.

3. Do store hot food in the refrigerator.

Storing hot food in the refrigerator raises the temperature in the refrigerator, which, in turn, raises the temperature of surrounding food.

4. Leave space around the refrigerator.

Leave enough space around the refrigerator to allow heat to escape. If heat cannot escape, the refrigerator will consume more energy.

5. Regularly check door gaskets and replace them as needed.

If a gasket is damaged, cold air might leak out, forcing the refrigerator to consume more energy. If you can slide a business card or similar object between a gasket and the main frame of the refrigerator, the gasket needs to be replaced.

常見問題 FREQUENTLY ASKED QUESTIONS

無法結冰時

→P.31

If you cannot make ice

→P.65

冰箱內冷度不夠時

→P.30

If the refrigerator is not sufficiently cold

→P.64

結霜或結露時

→P.30

If condensation or frost forms

→P.64

目錄

使用之前

安全上的注意事項	4
事前準備	8
使用前的準備	8
確認事項	10
各室的名稱・概略的溫度・存放食物	10
操作面板的功能	11

使用方法

冷藏室	12
各部位的名稱	12
在更低溫度下保存食品時（使用「Moisture Cooling」功能）	12
調節溫度	13
調整置物架・層架的高度	13
真空冰溫室	14
收納食品	14
變更真空冰溫室的設定	15
關閉真空冰溫門	15
製冰室（自動製冰機）	16
製冰方法	16
冰的收納量・製冰時間	17
急速製冰	17
製冰停止	17
告知給水警示燈	17
「On」或「Freeze」及「Fridge」閃爍時	17
冷凍室	18
收納食品／收納食品時	18
調節溫度	19
將食品急速冷凍（Quick Freezing）	19
蔬果保鮮室	20
收納食品／收納食品時	20
蔬菜保存要領	21
各種功能	22
溫度微調節（冷藏室・冷凍室）	22
蔬果保鮮室的溫度調節（「蔬果室強」）	22
箱門警報器	23
箱門警報器及操作音的音量調節	23
操作面板鎖定功能	23
三重抗菌除臭（冷藏室）	23
節電	24
「節電」模式的設定	24
eco 運轉標誌	24
冰箱門關閉顯示燈	24

保養方法

保養方法	25
電源插頭／箱門密封墊	25
箱門表面／各層架・置物架／置物盒	25
冰箱背面・地板／液汁承接處	25
真空冰溫室	26
給水槽	26
製冰機清潔	27
卸除組件的方法・安裝的方法	28
可調式層架上段・中段	28
固定層架	28
層架隔板	28
可調式層架下段	28
箱門置物架	28
真空冰溫室	28
製冰盒（製冰室）・上層冷凍盒（上層冷凍室）	29
中層滑動盒・下層滑動盒（下層冷凍室）	29
上層滑動盒・下層置物盒（蔬果保鮮室）	29
拉取式門的安裝方法（製冰室・上層冷凍室 下層冷凍室・蔬果保鮮室）	29
遇到問題時	30
遇到問題時	30
初次使用時	30
不冷	30
結霜・結露	30
太冷	30
自動製冰	31
箱門高低不平衡以及歪斜	31
操作面板的顯示燈正在閃爍	32
蔬果保鮮室	32
真空冰溫室的問題	33
有異味	34
冰箱發熱	34
聲音不對	34
其他	35
移動・搬運的準備（搬家時）	36
另購零件	36
有關碳氫化合物的冰箱／可容納的食品重量	71
關於售後服務	72

使用之前

使用方法

保養方法

遇到問題時

安全上的注意事項

請務必遵守

為了防止危害到使用者或其他人及造成財務上的損失，請務必遵守以下事項。

■以下將以標示方式，區分及說明忽視標示內容而誤用時所產生的危害與損失程度。



警告

此標示欄表示「可能會造成死亡或嚴重人身傷害」。



注意

此標示欄表示「可能會發生人身傷害或財產損失之預測內容」。

■以下將以圖示標示方式，區分及說明應遵守內容的種類。(以下為圖示標示例)



此圖示標示為「禁止」內容(請勿執行之事項)。



此圖示標示為「強制」內容(請務必執行之事項)。

■此冰箱使用可燃性的冷煤。以下的標示欄記載關於可燃性冷煤的注意事項。



R600a

此圖示標示為可燃性冷煤的注意事項。

警告

安裝時



- 為了避免因不穩定的器具造成的危險，必須按照指示書進行修理。
- 針對地震等天然災害做好防止翻倒處置。
 - 避免因翻倒而受傷。



禁止淋濕

- 請勿設置於潮濕或會被水淋到的場所。

· 避免因電氣絕緣不良而引起觸電· 火災的危險。



電源及電源電線



禁止

- 使用時請勿高於插座或配線器具的額定電流。
請勿使用交流額定電壓以外的電源。

若與其他電器插頭併用，或使用三面插座等，會因異常發熱而造成火災的危險。

· 請單獨使用額定電流 10A 以上的插座。



- 設置本產品時，請確認電線是否有拉扯、損傷的跡象。

(請勿讓電線受損·加工·接近發熱器具·勉強彎曲·扭曲·拉扯·乘載重物·讓冰箱壓住電線或捆綁電線。)

在已受損的狀態下使用時，會引發觸電·短路·火災的危險。

· 在電源線損傷的情況下，為了避免危險，必須由廠商、服務代理商或具有同等資格者進行更換。

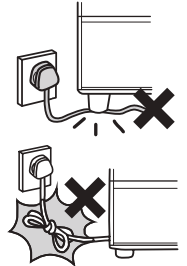

- 將插頭的電線向下，將插頭確實插入插座內。

· 如果插頭方向相反插入，會給電線增加負擔，成為短路·觸電·起火的原因。

· 如果插頭插得不夠完全，也將會成為因觸電，發熱而導致火災的原因。

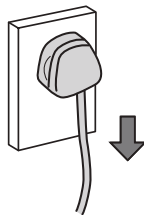

- 請定期清除插頭上的灰塵。

當插頭堆積灰塵時會因濕氣而造成絕緣不良，進而引起火災。
· 請拔除插頭再用乾布擦拭乾淨。

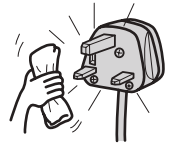

警告

電源及電源電線



禁止濕手

- 請勿用潮濕的手，拔除插頭。
· 會引起觸電。
- 該器具在獲得與以安全方法使用器具相關的監督或指導並理解其危險的情況下，即使 8 歲以上的兒童、身體、感覺、精神能力中的任一個都低下者、沒有經驗和知識者也能使用。



- 進行冰箱保養，請務必拔掉插頭。
有觸電或受傷的危險。
→ P.25
· 請將插頭確實的從插座內拔出。

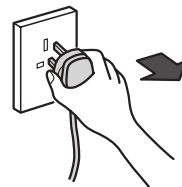

在一般使用的情況下



禁止淋濕

- 請勿用水淋濕主體與箱內。
· 避免因電氣絕緣不足而引起觸電、火災。



- 請勿將含水容器放在冰箱上。
· 翻倒的水會造成電氣組件絕緣不良而發生漏電、火災、觸電的危險。



禁止

- 請勿放入容易引火的物品。
· 揮發油、乙醚、LP 瓦斯、稀釋液、黏著劑會發生引爆的危險。

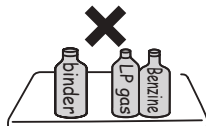

- 請勿用來保存藥品或學術試樣。
· 必須嚴格管理的物品，不可保存於家庭用冰箱內。



- 在附近請勿使用可燃性噴霧用品。
· 避免因箱門開關等電氣接點引起的火花引發火災。



- 請勿在冰箱上放置物品。
· 避免因開閉箱門，造成物品掉落而受傷。



- 請勿懸在箱門上嬉戲，或踏在收納盒上。
· 避免因翻倒，夾到手指而受傷。



- 請不要拆卸冰箱內燈的蓋子。
· 燈泡損壞時，須由製造廠商或其服務處或具有相關資格的人員加以更換以避免危險。

- 不要將箱門開得過大或靠在打開的箱門上等給箱門施加太強的力。

- 不要用力碰撞門。
- 請勿在設備後部放置多個可攜式插座或可攜式電源。



禁止接觸

- 請勿手觸自動製冰機的機械部位。
· 製冰盤旋轉時，手恐怕會受傷。



- 兒應監督兒童確保其不將本產品作為玩具。
- 不得由兒童在沒有成人監管的情況下實施清掃和維修。



警告



關於冷媒（由於這是一種可燃性的氣體 R600a：異丁烷，請注意以下的事項。）



禁止

- 不可以螺絲等銳利物品刮傷冰箱本體。
由於使用可燃性的冷媒，當冷媒從冰箱內壁的配管外洩，會有起火・爆炸的危險。

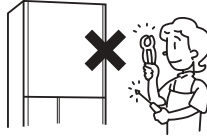

- 除廠商建議方法外，不得使用機械工具或其它工具來加速除霜的過程。
- 除製造商建議的方法外，請勿使用機械設備或其他方式加速除霜過程。
- 請勿在冰箱內部使用電器用品。
・如冷媒外洩，電氣接點所產生的火花，會有起火・爆炸的危險。



- 請勿損傷冰箱的冷卻管路。
冷媒配管損壞時，請將冰箱遠離火源並避免使用電器用品。
配管損壞時，請儘快將門窗打開，並與經銷商或日立技術中心聯絡。

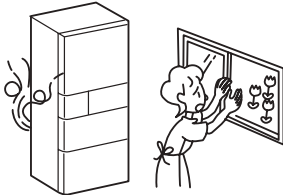

- 安裝的時候，在周圍要離開一些間隙，確保有足夠的散熱空間。
→ P.8
若冷媒外洩的情況持續，會有起火・爆炸的危險。

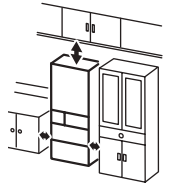

- 如需進行廢棄處理時，請聯絡經銷商或環保署資源回收中心專線，交給他們進行專業處理。
若冷媒外洩會有起火・爆炸的危險。



- 警告標籤和銘牌必須一直牢固張貼於壓縮器上和冰箱上。

- 使用過的可燃性製冷劑的處理、維修和安裝只能由日立授權服務公司或維修人員實施。

萬一有下列情形



- 當產品異常或故障時，請拔掉插頭停止運轉。
有觸電或受傷的危險。
・請務必在拔除插頭時握住插頭。

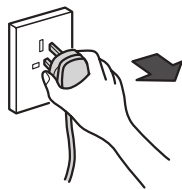

禁止分解

- 請勿自行分解・修理・改造。
避免發生火災，異常動作而受傷。
・需分解・維修時，請洽經銷代理商。



- 可燃性氣體外漏時，勿接觸冰箱，請立即開啟窗戶進行換氣。
・避免因箱門開關等電氣接點的火花，而發生引爆・火災・燙傷等危險。

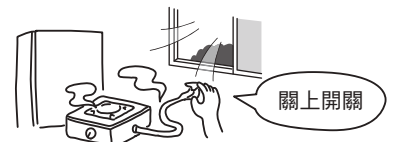

廢棄處理時



- 在等待廢棄物再利用保管之際，因有幼兒被誤困在箱內之虞，請將門墊拆下來。



⚠ 注意

移動・搬運時



禁止

- 請勿在容易刮傷的地板上使用冰箱滑輪。
避免因滑輪而刮傷地板。
· 請在容易刮傷的地板上鋪上保護板。
- 請勿以吊車吊起把手部位。
- 請勿碰撞冰箱背面・側面。

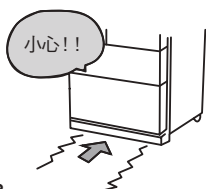

- 搬運時，請用手持手把搬運。
倘若沒有手持把手，可能會因手滑而受傷。
· 請僱用 2 人以上手持手把搬運。
· 搬運時請如圖示般將箱門朝上。
· 請不要用起重機等吊起把手。
· 為了防止電源插頭、電線下垂，請以膠布固定。



在一般使用的情況下



禁止

- 請勿在超大瓶飲料的縫隙間再塞入其他瓶罐。
· 勉強放入超大瓶飲料瓶後，在關閉箱門時，可能會因掉落而受傷。
- 請勿將瓶子放在冷凍室內。
· 內容物結凍會使瓶子破裂，容易受傷。



- 當打開冰箱門時，若其他門也在進行開閉動作時，為了避免被打開的冰箱門之間夾傷手或手指，請格外注意。

- 關閉冰箱門時，請勿握住冰箱門把手以外的部位進行關閉。

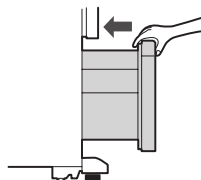

- 開啟最底層的箱門時，請勿讓腳靠近冰箱。
· 避免在開啟箱門時，碰觸到腳底而受傷。



- 手腳不要放進冰箱的底部。
清理時將手伸入冰箱底下時，可能會被鐵板割傷。

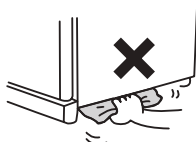

- 請勿施加強烈撞擊力於玻璃層架。(可能因玻璃層架破裂而導致受傷)

- 請勿讓食品凸出層架。
· 避免因鈎到瓶罐後掉落而受傷。

- 開關冰箱門時，請勿過於用力。
(存放的食品有可能會掉落)

- 他人同時觸摸時請勿進行開閉動作。

- 在某扇冰箱門打開的狀態下關閉另一扇門時，請勿將手放在門之間，以免夾傷手或手指。



- 請勿用潮濕的手碰觸冷凍室內的食品或容器。
· 避免凍傷。(尤其是金屬製產品)

- 請勿食用有異味，已變色的食品。
· 避免因食品腐敗而引發疾病。

- 請勿在玻璃層架的玻璃面上加熱，或放置熱的物品。



- 為了防止水滴到地板上。
長時間門與冰箱間有縫隙時，結露水或除霜水可能會滴下。請確實關緊冰箱門讓門與冰箱之間沒有縫隙。

- 冰箱門開啟的狀態下，開啟其他的門時，請注意切勿被開啟的冰箱門夾傷手或手指。

- 因為玻璃層架很重，安裝、拆卸時請格外注意。

- 關閉冰箱門時，若有異常聲音或磨耗粉末掉落等異常現象時，請停止使用，並請維修人員到府察看。

事前準備

使用前的準備

1 設置在以下的場所

- 堅固·水平的地板
地毯·榻榻米（日式草蓆地板）·木板地·塑膠地板等恐怕會有變形·變色的可能，請墊（超過 1cm 厚的）板材。
- 避免陽光直射和高溫
這些可防止冷卻功率下降，避免電費增加。
- 不潮濕·空氣流通的地方
而且可抑制變色以及生鏽。
- 與其他的電器間隔一段距離
防止對電視等造成雜音或影像不安定等情形。

- 請預留散熱空間（右圖）
※本體側面的中央部分是比所表示的尺寸稍大。
設置時請確保充裕的空間。
- ※若擔心背面牆壁變色或髒汙時，請預留間隙（2cm 以上）。另外也可以防止震動音，或濕氣較高時的背面牆壁的結露情形。

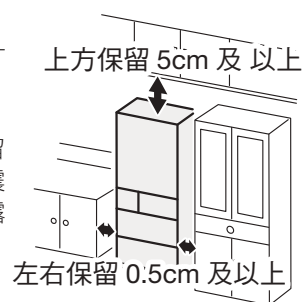

2 調整冰箱水平後固定。

1 手持腳座護蓋兩端，用力拉向身前方向將其卸下。

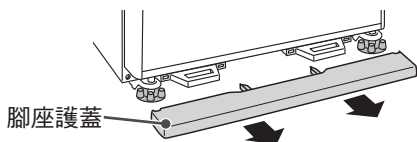

2 旋轉左右的調整腳，直到碰觸到地板。調整冷藏室的左右側門直到平行為止。

調整腳的旋轉量是，每旋轉 1 圈相當於箱門的高低差距 1mm。
請用專用工具配合調整腳的形狀並夾住。

■ 右側下歪

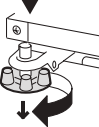
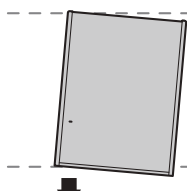

依順時針方向
旋轉左邊的調
整腳，即可讓
左側降低

■ 左側下歪

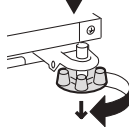
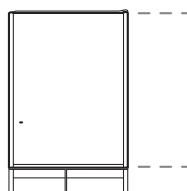

依順時針方向
旋轉右邊的調
整腳，即可讓
右側降低

- 當過度旋轉調節腳時，可能導致調節腳脫落。

調節腳的形狀因製造時期而異。
若形狀為 B，可用十字螺絲刀進行調整。
請確認調節腳的形狀，並調整一下。

調節腳形狀為 A 時



無法使用十字螺絲刀
進行調整。

調節腳形狀為 B 時

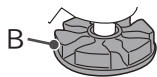

十字螺絲刀

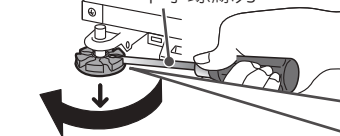

可用十字螺絲刀調整。

- 旋轉調節腳時，請使用十字螺絲刀並請注意勿傷及地板。

3 請將腳座護蓋的卡榫插入冰箱的安裝孔內安裝。

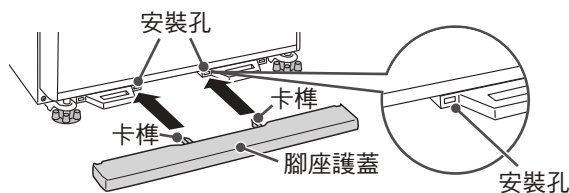

通知事項

- 包裝規格可能因製造時期而異，在品質方面沒有問題。
- 因地板材質的強度、食品的重量，在經過數日後（約 5 天）或許發生雪櫃門往下降低的情況。若發生此情形，請再次調整平行。
- 可能會因雪櫃放置在非水平的場所，或是地板材質柔軟，而導致雪櫃門左右出現高低差。雖然功能上沒有問題，但若介意請按左側所列的步驟進行平衡調整。
- 進行左右水平調整，並使雪櫃的前側稍微高一點可方便關門以避免門沒關緊。
- 在雪櫃門開啟的狀態下，手若放開後，雪櫃門可能會慢慢自行關上，此情況非故障。

十字螺絲刀的大小參考

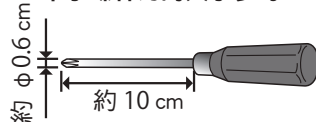

使用十字螺絲刀時，請確實插入調節腳的溝部後旋轉。

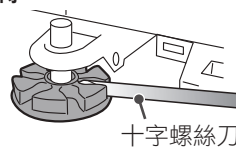

十字螺絲刀

3 清潔冰箱內部 →P.25 ~ 27

- 請用沾濕的柔軟布擦拭後，再以乾布擦乾。
- 請將給水槽、淨水濾網、製冰盤以清水沖洗。

※抽屜門的滑軌及滑軌接觸面上塗有潤滑劑，請勿擦拭。
(該潤滑劑是符合食品衛生法)

※剛開始使用時可能會有些許塑膠的氣味。

若特別在意時，為了讓該氣味不留存在室內，請保持室內通風良好。(使用後此氣味不久即消失)

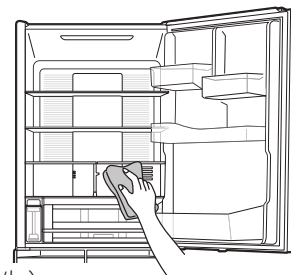

4 將電源插頭插入

設置後直接就可插上電源插頭。

請用獨立的插座。(電源 220 ~ 240V、額定電流 10A 以上)

- 請確認電源插頭及電線是否夾在冰箱背面及牆壁中間。為了防止電線發熱。

冰箱內開始冷卻 (冷卻冷藏室後，冷卻其他儲藏室 (製冰室、冷凍室、蔬果保鮮室))

- 根據冰箱周圍溫度、食品的存放方式不同，冰箱內充分冷卻約需要 4 小時。
夏天天氣炎熱時，也有可能需要 24 小時以上。

在冰箱尚未充分冷卻前請勿將冰淇淋或未充分冷卻的食品、易受損的食品，放入冰箱。

- 初次使用自動製冰時，請操作自動製冰機的「製冰機清潔」。(→P.27)

- 自動進行連續的製冰運轉是必須在冰箱內充分冷卻之後才能開始。

(初次使用時，最初的結冰可能需要花 24 小時以上。)

- 當冰箱內溫度較低時，插入電源插頭後有可能經過 10 分鐘才開始冷卻。

通知事項

- 配管有可能需要加以防鏽處理。

當冰箱設置在溫泉地區、工業地區周圍、下水道管路附近等處，有可能受到硫化氣體的影響而導致配管的腐蝕。請向經銷店諮詢。
若因氣體危害導致配管變黑或是故障時，不在保固對象之內。

- 將電源插頭插入後，會有馬達運轉聲音。此外，冰箱在達到充分冷卻之前，壓縮機及風扇可能會發出較大的聲音。

- 請勿將背面的標籤撕下，或拆卸側面下方的塑膠製品。

- 磁鐵裝飾或是吸盤吸附在冰箱本體或冰箱門表面有可能會留下痕跡。

- 周圍溫度較高時，因冰箱門表面產生露水，貼在冰箱門的紙等，有可能會吸濕。

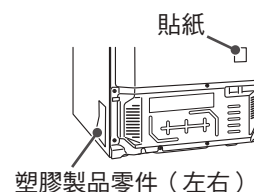

確認事項

各室的名稱・概略的溫度・存放食物

冷藏室 → P.12
 層架：約 2°C ~ 6°C 置物架：約 2°C ~ 9°C

日常使用的食品

真空冰溫室 → P.14
 約 -2°C ~ 0°C

製冰室
 → P.16
 約 -19°C ~ -17°C

貯冰空間
 自動製冰機所製作的冰塊

上層冷凍室
 → P.18
 約 -19°C ~ -17°C

下層冷凍室
 → P.18
 約 -20°C ~ -18°C

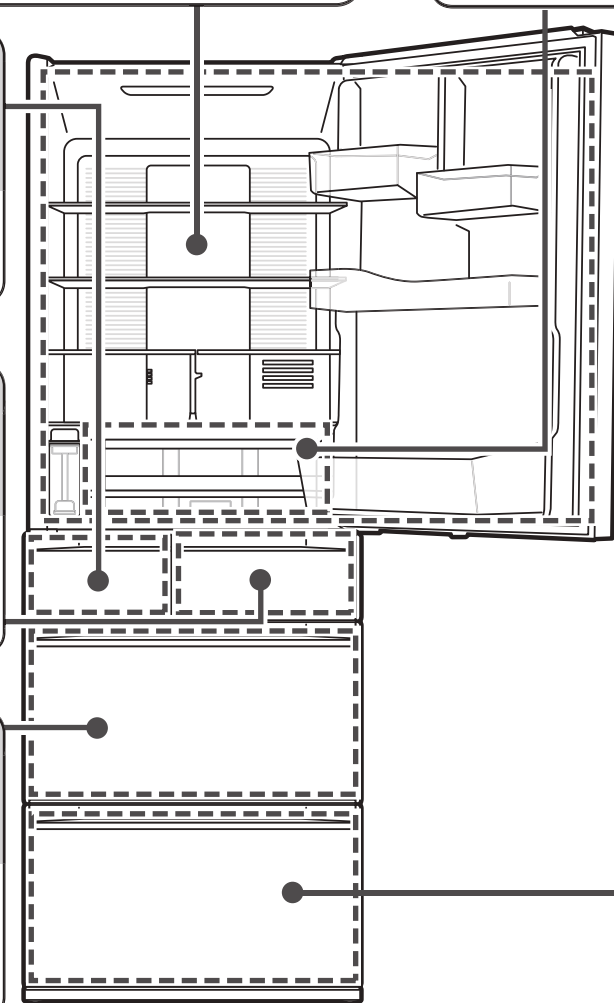

蔬果保鮮室 → P.20
 上層・下層存放空間：約 4°C ~ 8°C

上層存放空間 下層存放空間

使用過的蔬菜、
 小型蔬菜、水果等

葉菜類（菠菜、小
 松菜等）、大型蔬菜
 （高麗菜、萵苣等）

豎放儲存區：約 4°C ~ 9°C

豎放儲存區

較高大的蔬菜及寶特瓶

※是在環境溫度 32°C、冷藏室與冷凍室都設定為「■■■」、不放食物、關著門、溫度穩定時的目標溫度。

此外，這是未設定成「Veg」時的溫度。

※因食品的存放狀態及箱門的開關動作，溫度可能會變動。

保存的訣竅

- 收納時請保留食品間的空隙。
- 建議您在存放強烈氣味食物時，先以保鮮膜包覆之後再放入冰箱。
- 可以收納食品重量的大概基準。 → P.71

操作面板的功能

操作面板的上段為顯示部、下段為操作部。

顯示部及操作部通常為熄燈狀態。請觸按 **MENU** 讓其顯示亮燈。

操作部為觸控式面板。請觸按面板來切換設定。

告知之顯示

eco	減少電力消耗，啟動運轉時顯示燈亮燈 →P.24
🔒	操作面板按鍵鎖，上鎖時顯示燈亮燈 →P.23
Water	當給水槽中的水減少時，顯示燈亮燈 →P.17
Door	冰箱門開關次數多時則顯示亮燈 →P.24

※為了更清楚說明，所有的顯示都呈燈亮的狀態。

最初碰觸 MENU 鍵

eco	■■■	Quick	Moist Cool	On
🔒	■■	On	Quick Freeze	Off
Water	■	Off	Veg	Off

顯示部分

MENU

Energy Saving
Button Lock
(Press 3 Sec.)

Freezer

Fridge

Ice Maker
Cleaning
(Press 5 Sec.)

Powerful
Moist Cool
(Press 3 Sec.)

Vacuum

節電設定

將各室的冷卻減弱，節省電力。

Save (節電) →P.24

溫度設定

平常請設定在「■■■」的位置。

冷藏室 →P.13

冷凍室 →P.19

製冰設定

Quick (急速製冰) →P.17

On (製冰) →P.16

Off (製冰停止) →P.17

設定冷卻模式

Moist Cool (低溫冷藏) →P.12

Quick Freeze (急速冷凍) →P.19

Veg (蔬果室強) →P.22

真空冰溫室設定

On →P.15

Off (關) →P.15

操作部

通知事項

- 觸按 **MENU** 鍵時，所有顯示亮燈後，即顯示目前的設定狀態。此外，打開冷藏室門，亦可顯示目前的設定狀態。
- 操作結束後，再次觸按 **MENU** 鍵時，顯示部及操作部的顯示會熄燈。
此外，縱使不觸按 **MENU** 鍵，經過約 40 秒，為節省電力，顯示部及操作部的顯示會自動熄燈。
但，設定成「節電」模式時，「Quick」的運轉顯示及「Off (製冰停止)」、「Water」、「Quick Freeze」、「Off (關)」的顯示、環保節能運轉中的 [eco 運轉顯示] [冰箱門開關顯示] 不會熄燈。
- 打開冷藏室門時，顯示部及操作部會亮燈。關上冷藏室門約 15 秒後則熄燈。
- 觸控面板會根據周圍的溫度、濕度、使用者的身體狀態及旁邊的電器製品的使用狀況，其反應會有所變化。
- 按了也沒有反應 (顯示內容不變) 的時候，請把手指離開一下再按。兩次按按鈕的時間間隔過短有可能導致檢測出錯誤訊息 (感應為持續按)。用力按也不會改善感應度的。
- 操作部濕或髒了的時候，會沒有反應。請用沾濕的布將髒污擦拭後，再以乾布擦乾。
- 冷藏室門打開時，或顯示部閃爍時觸按操作部則不會有任何反應。

冷藏室

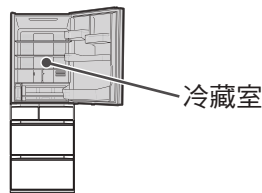

各部位的名稱

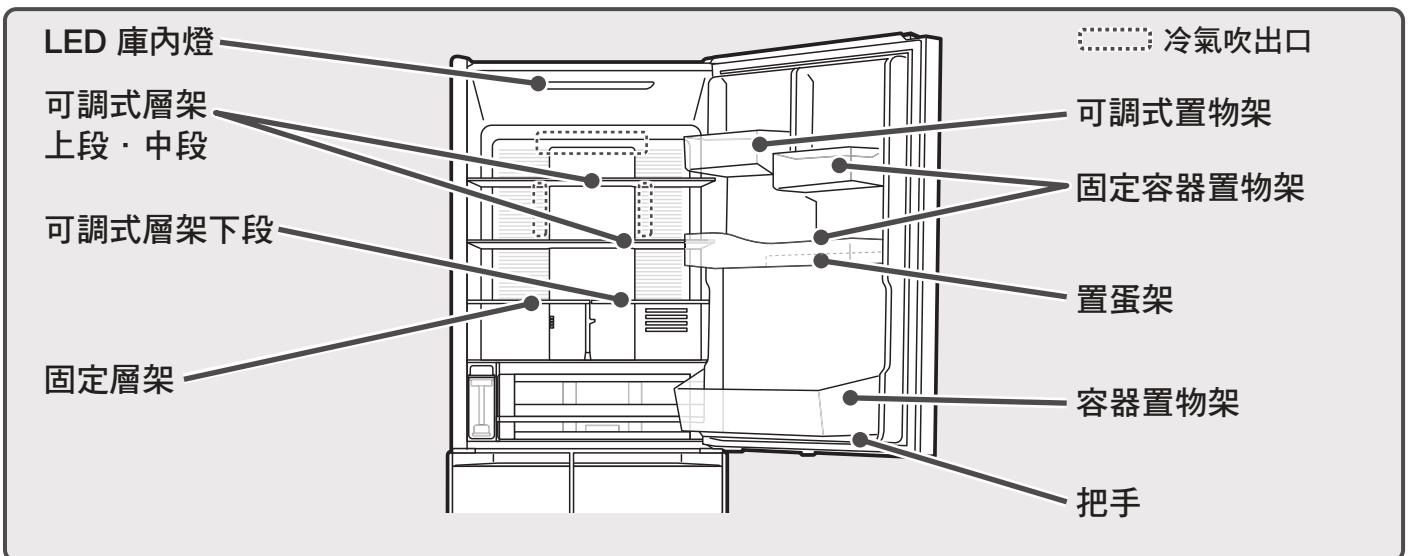

提示

- 若將水分較多的食品或罐裝飲料，放置在冷氣吹出口前，有可能結凍或破裂，請勿將該類食品放置在冷氣吹出口前。特別是設定成「■■■■」「Moisture Cooling」時，更容易結凍。將食品加蓋或包裹保鮮膜，可以防止食品的結凍。
- 將米·海苔等的乾燥食品放置在蔬果保鮮室收納時，請裝入密閉的容器（袋）後再收納於蔬果保鮮室內。乾燥食品容易吸收溼氣。

在更低溫度下保存食品時（使用「Moisture Cooling」功能）

- 將電冰箱的所有隔層設為較低的溫度（約 0°C~3°C）。
建議您利用此功能存放加熱的菜肴和需要較長時間保存的食品。
您可以保存溫熱的食品（例如，可以將溫熱的鍋直接放入），而不必擔心會影響電冰箱內其他食品的冷藏。
放入溫熱食品時，請注意先將食品冷卻到可以用手觸摸的溫度（約 50°C 以下），以防止燙傷或層架變形。
- 能夠在操作面板上確認是否設定為「Moisture Cooling」。
在「Moist Cool」點亮期間，設定為「Moisture Cooling」。

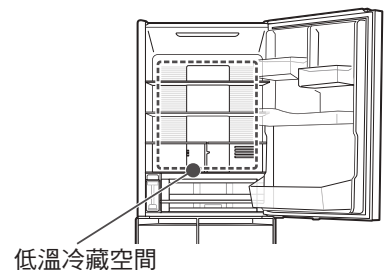

通知事項

- 設定為「Moisture Cooling」時，耗電量比「■■■」多。並且運轉聲音有時增大。
- 設定為「Moisture Cooling」時，置物架的溫度也低於「■■■」。

設定方法

購買時設定成「關」的狀態。

1

按下操作面板的 **MENU** 按鍵，顯示燈亮

顯示燈全部燈亮後，顯示目前的所有設定。

2

長按 3 秒以上直到 **Powerful** 的設定音發出（嗶—），讓「Moist Cool」燈亮

Fridge 的溫度設定熄滅。

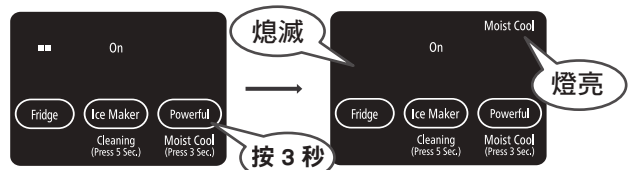

解除

按下操作面板的 **MENU** 按鍵，讓顯示燈亮，長按 3 秒以上直到 **Powerful** 的設定音發出（嗶嗶），讓「Moist Cool」熄滅

調節溫度

通常時，請設定為「■■■」。若夏天，感覺冷度不夠時，請設定為「■■■■」。

1

按下操作面板的 **MENU**，顯示燈亮

顯示燈全部燈亮後，顯示目前的所有設定。

2

按下 **Fridge**，可以變更適當的溫度



冷藏室的概略溫度

「■■■■」比「■■■」溫度低約 1 ~ 3°C
「■」比「■■■」溫度高約 1 ~ 3°C

敬請依照指示操作

- 在冬天，長時間設定為「■■■■」時，食品有可能因而結凍。若覺得冰箱內太冷時，請設定為「■■■」或是「■」。

通知事項

- 溫度因使用條件而有所變動。
- 調節更細微的溫度時 (→P.22)
- 設為「■■■■」時 比設為「■■■」時更耗電。
- 當變更冷藏室的溫度設定時，真空冰溫室的溫度也隨之改變。
- 設定為「Moisture Cooling」時，不能設定冷藏室的溫度。

調整置物架・層架的高度

配合食品或飲料的大小，置物架及層架的位置可以做適度的調整。關於拆卸方式・安裝方式，請參閱 (→P.28)



注意

■操作玻璃層架時

- 請勿對玻璃層架施加強力的撞擊。
(玻璃層架可能因破裂而導致受傷)
- 因玻璃層架較重，安裝，卸除時請特別小心。

■可調式層架上段・中段 可調式置物架

配合食品及飲料的高低可以做適度的調整。

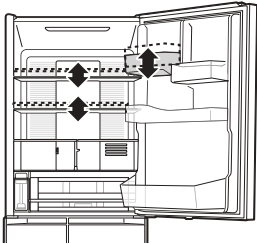

■可調式層架下段

調節可分為 3 個階段。

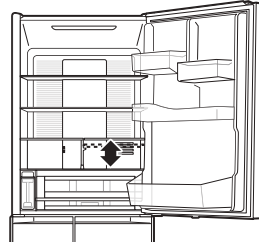

●剛購買時的狀態

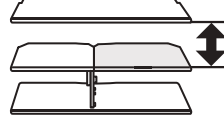

●收納鍋子等



●收納裝牛奶的紙盒等

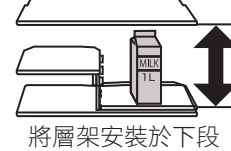

真空冰溫室

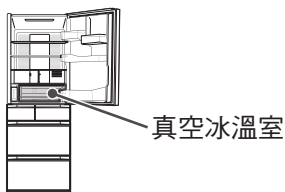

LED 庫內燈
打開冷藏室門時，
照亮真空冰溫抽屜。

真空幫浦

**真空冰溫盒
(附鋁製托盤)**

把手

白金觸媒 利用白金觸媒的效果，將肉類·魚類所散發出的氣味成分分解，
轉變為碳酸氣，因而抑制食品鮮度的降低。

把手

真空解除閥 (藍色)
將把手拉起解鎖的話，會解除透過
真空解除閥進行的真空功能。
解除真空時會有「咻」的聲音。

收納食品

購買時，設定成「On」。

<p>On (約-2°C~0°C)</p>	<p>● 肉類·加工肉品 ● 魚貝類·海鮮類·魚類加工食品 ● 肉類、魚類的解凍</p> <p>· 水分多的食品，可能會結凍。</p>
<p>Off (約-2°C~0°C)</p>	<p>真空功能停止運作。建議存放需裝在「密封袋」、「密封容器」的食物時選擇該模式。因為是冰溫室， 含水分較多的食物可能因低溫而凍結。</p>

通知事項

- 縱使食品以保鮮膜包覆，也不會改變真空的效果。若擔心氣味轉移至其他食品時，請以保鮮膜包覆。

注意事項

- 周圍溫度低時，水分較多的食物可能因低溫而凍結。
- 將冷藏室的溫度設定調至「■■■■」或是「■」時，真空冰溫室的溫度會稍有改變。
- 請勿將過多的食品或容器塞入真空冰溫室。
可能會導致真空冰溫抽屜無法拉出。

■ 不宜存放於真空冰溫室的食品

以下食品不宜冷凍。請在冷藏室中保存。

● 乳製品



乳酪等

● 切好的蔬菜、水果



切好的生蔬菜、水果

● 結凍時會造成品質、 口感變差的食物



豆腐、魔芋、炸豆腐、
魔芋絲、水煮蛋

變更真空冰溫室的設定

1

按下操作面板的 **MENU** 按鍵，顯示燈亮

顯示燈全部燈亮後，顯示目前的所有設定。

2

按下 **Vacuum** 按鍵，可依照個人喜好變更設定

按下按鈕時依下列的順序切換。購買時設定為「On」。

注意事項

- 當設定為「Off」時，「Off」的顯示持續亮燈。
為達到省電目的，約 40 秒顯示燈即熄燈，所設定的功能將持續有效。

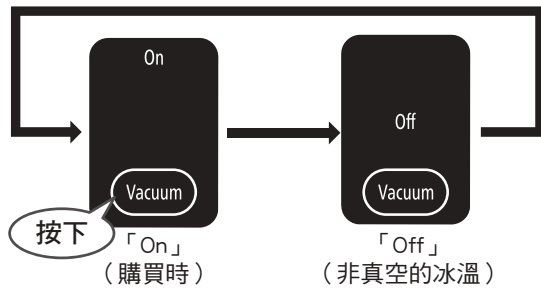

開閉真空冰溫室門

開啟箱門時

1

將把手往上扳起，解除鎖定

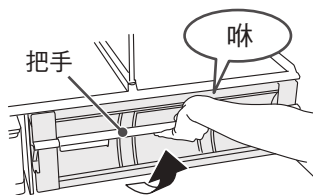

※真空幫浦啟動後至達到真空狀態，約需 3~4 分鐘。
在 4 分鐘以內打開真空冰溫盒，有可能沒有“啾”的聲音。

2

將真空冰溫盒往前拉出

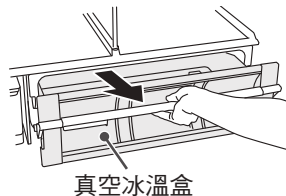

※若能聽到“啾”的聲音時，因為是正在解除真空的狀態，無法拉出真空冰溫盒。請在聲音消失後再往前方拉出。

關閉箱門時

1

將真空冰溫盒往內推進

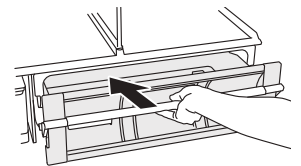

2

將把手往下扳，讓其鎖定

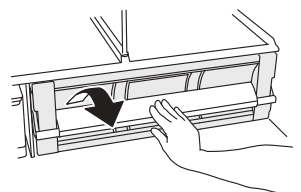

注意事項

- 若沒有將把手確實地往下扳，則無法形成真空狀態。
- 在未鎖定把手的狀況下關上冷藏室門，則可能造成零件、食品的破損，或是門縫間產生間隙，造成無法充分冷卻的原因。

敬請依照指示操作

- 若密封墊緊貼著，則無法維持密封狀態。若緊貼時，請將其剝離。因為左右面及下面無法看清楚，請將真空冰溫盒拆卸後進行確認。 →P.33
- 因為真空冰溫室是密閉的狀態，食品和空氣中所含的水分，有可能在冰溫室內結成水滴或結霜、結冰，請以柔軟的布沾溫水擦拭。(產生水滴或結霜、結冰時，並不會對性能造成影響。)
- 若您在意食品上有水滴、霜、結冰，建議您在存放食品時，以保鮮膜包裹。
- 真空冰溫室內若水或食品的液汁溢出時，請立刻擦拭乾淨。
- 白金觸媒不須要更換。請勿將其拆除。

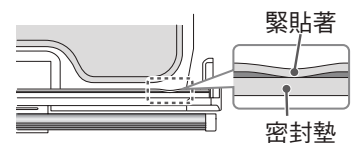

水滴、結霜、冰



製冰室 (自動製冰機)

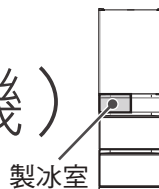

給水槽
(容量約 1.0L)

製冰盒

製冰功能切換鍵

自動製冰機

製冰方法

初次製冰時、或一星期以上沒有製冰時，請操作「製冰機清潔」。 → P.27

- 1 按下操作面板的 MENU 按鍵，顯示燈亮**
顯示燈全部燈亮後，顯示目前的所有設定。
- 2 按下 Ice Maker 按鍵，「On」顯示燈亮。**
購買時，設定為製冰「開」(燈亮)的狀態。
- 3 將給水槽往水平方向拉出。**
※拿起給水槽往身邊拉，有時候會感覺到重量比較重。
- 4 打開給水槽蓋加水**
※請勿加水至滿水線以上。
- 5 再裝回給水槽**
往前推入到超過「水槽安裝位置」的線位。
如果不會將給水槽確實的往內退進的話，將無法製冰。
※給水槽傾斜的話水可能會溢出來。水溢出來時請馬上擦乾淨。
- 6 自動開始製冰運轉**

 - 當冰塊積滿至滿冰線時，則會暫時停止製冰功能。當冰塊減少時，會自動啟動製冰功能。
 - 當製冰盒內的沒有冰塊時，從製冰盤掉落冰塊，可能會有較大的聲音。

提示

- 注意：只可加入飲用水。
- 製冰用水根據貴國的飲用水標準而定。自來水的水質因不同國家而異。請向地方當局檢查、核實。
- 因衛生上的理由，請至少每週更換一次水，並清洗容器。 → P.26
- 使用含豐富礦物質的礦泉水製作冰塊時，會產生白色的粉末，這是礦物質成分，對人體無害。
- 如下列所示，因為容易受到細菌污染，平常請三天清洗容器一次。



礦泉水
(硬度：100mg/L 以下)



過濾水或
煮沸後的水



井水
(皆須符合飲用水質標準。)

- 由於會導致故障，或是會造出畸形·連體的冰等，請不要使用這些(液體)。



果汁類



運動飲料水



汽水



茶

冰的收納量・製冰時間

型號	R-HWS480K type	
冰的收納量	將冰塊整平	約 140 個
一次 (12 個) 的製冰時間	通常的「On」	約 110 分~ 140 分
	「Quick」	約 80 分

※周圍溫度 30℃，各冰箱的溫度設定在「■■」的位置，無開關冰箱門狀態的約略值。

通知事項

- 若冰塊堆積一處，即使冰塊較少，也會停止製冰。

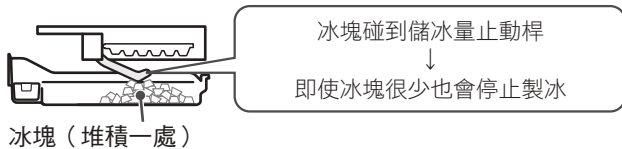

- 將冰塊往前整平的話就可以製造出更多的冰塊。

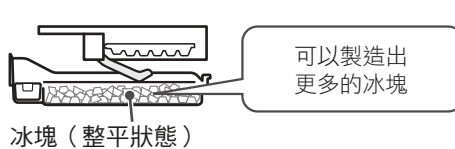

- 下列的情形時，可能會延長製冰的所需時間。

- ・開始使用時 (可能需要 24 小時以上)
- ・設定成「Energy Saving」模式時提示
- ・冷凍室溫度設定為「■」時
- ・冰箱門開關次數頻繁時
- ・冰凍室或製冰室門呈半開的狀態
- ・冬天周圍溫度較低時
- ・停電時

提示

- 設定成「On」「Quick」時，貯冰空間，除了自動製冰機所製造的冰塊之外，請勿放入其他的冷凍食品。(有可能造成無法製冰、或因食品接觸到製冰機的零件而導致門無法開啟、零件破損等情形。)
- 請慢慢的開關製冰室門。若開關時用力過猛，冰塊可能從製冰盒掉落至下層冷凍室。

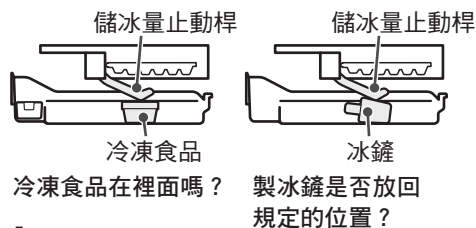

急速製冰

- 1 按下操作面板的 **MENU** 按鍵，顯示燈亮
顯示燈全部燈亮後，顯示目前的所有設定。

- 2 按下 **Ice Maker** 按鍵，**「Quick」** 顯示燈亮
約 7 小時「Quick」的運轉則自動停止，切換至「On」模式。
通知事項
 - 「Quick」在運轉中時「Quick」顯示燈亮。[eco 運轉顯示燈] 則不會亮。
 - 由於「Quick」運轉時優先冷卻冷凍室，因此冷藏室門開關次數頻繁時，冷藏室的溫度容易上升。

製冰停止

- 1 按下操作面板的 **MENU** 按鍵，顯示燈亮
顯示燈全部燈亮後，顯示目前的所有設定。

- 2 按下 **Ice Maker** 按鍵，**「Off」** 顯示燈亮
※一星期以上「Off」時，自動製冰機則需進行清潔。
→P.27

告知給水警示燈

給水槽的水量減少時，「Water」顯示燈亮。請補充水至給水槽內。

開關冰箱左門時，「Water」指示燈會暫時熄滅。若沒有補充水，將會再次亮燈。(最長 3 小時後)

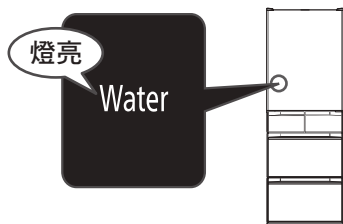

通知事項

- 自動製冰機設定為「Off(製冰停止)」時，「Water」指示燈不會亮燈。
- 即使給水槽中有水，若未確實推入給水槽，「Water」指示燈也不會亮燈。請將給水槽確實往前推入至固定位置。
- 設定成「On」時，當滿冰的狀態時，有可能的指示燈不會亮燈。

Ice Maker「On」或 Freezer「■■■■・■」及 Fridge「■」閃爍時

製冰盤有可能碰到製冰盒內的食物。

請將製冰盒內清空，然後操作「製冰機清潔」。→P.27



冷凍室

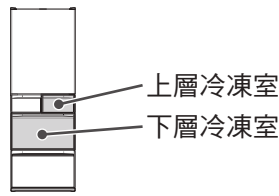

上層冷凍室

請將日常使用的食品或使用過的食品保存於此。

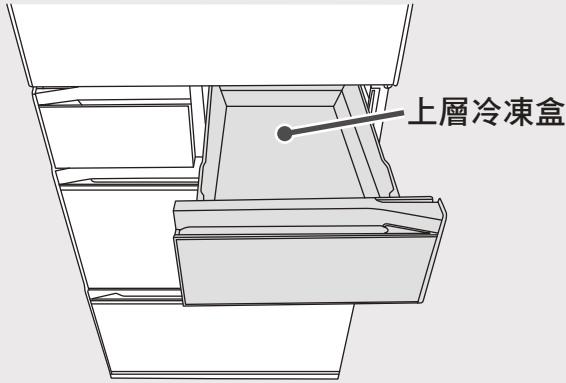

下層冷凍室

內配 3 層冷凍盒，能夠充分地存放，整齊地收拾。
適合存放需長期保存的東西、容易融化的冰淇淋等。

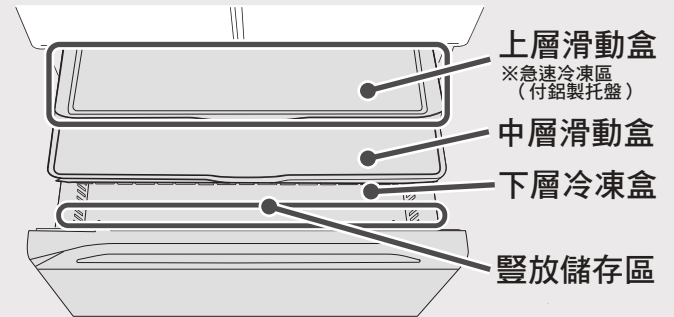

注意事項 ● 請勿拆下上層滑動盒。

收納食品

上層冷凍室		冷凍包裝、密閉容器、吐司麵包等
下層冷凍室	上層滑動盒	小件物品，冷凍食品等 (急速冷凍區) 肉類、魚類、白飯急速冷凍時
	中層滑動盒	冷凍包裝，密封容器等
	下層冷凍盒	冷凍食品，麵包，冰淇淋等 (豎放儲存區) 存放冷凍專用寶特瓶等

收納食品時

請配合食品的種類、大小來收納。收納食品的高度，請參考各收納盒的端面。收納食品時，請勿觸及上面的收納盒或隔板。

可能因箱門沒有完全關緊，而造成不夠冷的情形。此外，也可能造成食品、盒子破損的情形。

注意事項

- 上層滑動盒裡請勿存放 500ml 的塑膠瓶。塑膠瓶凍結後會膨脹，導致中層滑動盒拉不出來。
- 請勿將上層滑動盒或中層滑動盒拆下。食品會掉落到下層冷凍盒的後面，導致門無法關緊。
- 請只使用於存放冷凍對應的寶特瓶類及能夠冷凍的食品。

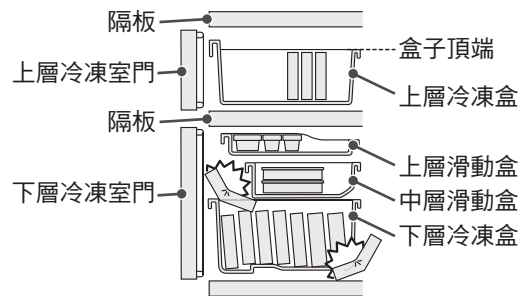

調節溫度

購買時，設定成「■■■」。通常時，請設定為「■■■」。若夏天，感覺冷度不夠時，請設定為「■■■■」。

1 按下操作面板的 **MENU** 按鍵，顯示燈亮

顯示燈全部燈亮後，顯示目前的所有設定。

2 按下 **Freezer** 按鍵，可以變更適當的溫度



冷凍室的概略溫度
「■■■■」比「■■■」溫度低約 2 ~ 4°C
「■■■」比「■■■」溫度高約 2 ~ 4°C

敬請依照指示操作

- 若覺得冰箱內太冷時，請設定為「■■■」或是「■■」。

通知事項

- 溫度因使用條件而有所變動。
- 調節更細微的溫度時 **→P.22**
- 設為「■■■■」時 比設為「■■■」時更耗電。
- 當變更冷凍室的溫度設定時，製冰室的溫度也隨之改變。

將食品急速冷凍 (Quick Freezing)

搭配鋁製托盤的效果，可以更快速將食品冷凍。

請將食品用保鮮膜包裹或裝入冷凍袋後放置在鋁製托盤上。
將食品分成薄型小包裝，不只是可以迅速冷凍至食品內部，也便於取出。

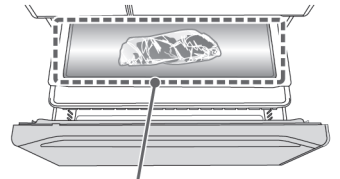

急速冷凍區

- 食品請勿重疊，將食品平放於鋁製托盤，可以提高冷凍的效率。

■ 設定方法

購買時設定成「關」的狀態。

1 按下操作面板的 **MENU** 按鍵，顯示燈亮

顯示燈全部燈亮後，顯示目前的所有設定。

2 按下 **Powerful** 按鍵「Quick Freeze」顯示燈亮

「Quick Freeze」運轉中時，「Quick Freeze」持續顯示亮燈。[eco 運轉顯示燈] 則熄滅。

約 90 分鐘運轉自動結束，「Quick Freeze」顯示自動熄滅。



中途解除 按下操作面板的 **MENU** 按鍵，顯示燈亮

按下 **Powerful** 按鍵「Quick Freeze」顯示燈熄滅

通知事項

- 「Quick Freeze」中，為了優先冷卻冷凍室，特別是冷藏室的門開關頻繁的時候，冷藏室的溫度容易升高。
- 「Quick Freeze」結束後的 60 分鐘以內，再次按 **Powerful** 鍵時，雖然「Quick Freeze」顯示燈亮，但「Quick Freeze」不運轉。60 分鐘過後才恢復運轉。
- 為了防止食品粘在鋁製托盤上，請務必包上保鮮膜。
- 「Quick Freeze」運轉中會比平常更耗電。

蔬果保鮮室

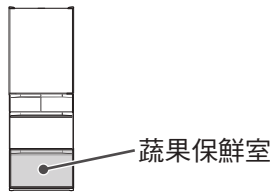

蔬果保鮮室

白金觸媒盒 將食品所散發出的氣味成分、蔬菜所散發的乙烯氣分解，轉變為碳酸氣，因而抑制食品鮮度的降低。

豎放儲存區

上層滑動盒

下層置物盒

※如果要拆下上層滑動盒，請拆下隔板。隔板有時會掉落。

上層存放空間

蔬果保鮮室門

隔板

下層存放空間 (蔬果睡眠保鮮空間)

收納食品

上層存放空間	未使用完的蔬菜、小型蔬菜、水果等
下層存放空間	葉菜類 (菠菜、小松菜等)、大型蔬菜 (高麗菜、高苜等)
豎放儲存區	較高大的蔬菜及寶特瓶

收納食品時

請配合食品的種類、大小來收納。

- 請注意收納食品的高度。
 - 冰箱門無法確實關緊，可能造成冷卻效果變差。此外，也可能造成食品、盒子的破損。
 - 可能會因為食品及寶特瓶的種類而無法收納的情況產生。
- 請勿將上層滑動盒卸除的狀態下使用。
 - 食品可能會掉落到滑動盒的內側，可能而導致門無法關緊。
- 請勿將過量的食品、飲料等強硬塞入。
 - 可能造成隔板或盒子的破損。

高度的基準

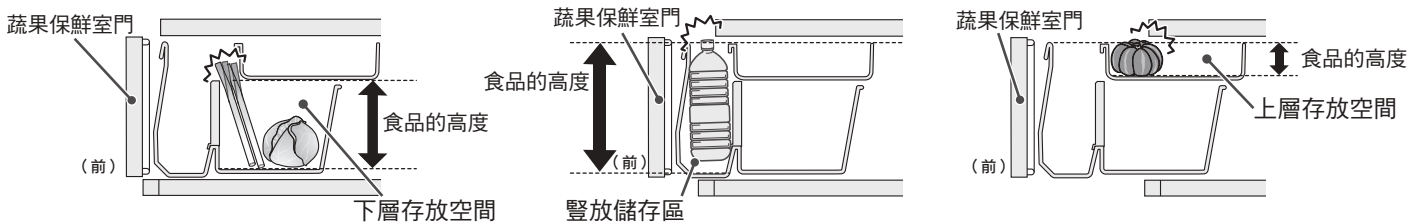

蔬菜保存要領

■建議常溫保存的蔬菜

- 大蒜、洋蔥、馬鈴薯、番薯和南瓜（圓形）保存在陰冷的場所（室內保持恒定低溫且不受陽光直射的場所）



■可能發生低溫障害

長期放在蔬果保鮮室內，因食品種類而異，可能會變色，風味減低。

此外，也有可能維他命C含量減低、發霉、腐敗。

容易引起低溫障害的食品

- 蔬菜…蕃茄、青椒、黃瓜、茄子、四季豆、地瓜、秋葵等
- 水果…香蕉、鳳梨、芒果、木瓜、酪梨、檸檬等



通知事項

豎放儲存區比其他空間的溫度稍微高。

這種場合

- 收納較少蔬菜時，因為無法保持較高的溼度，請用保鮮膜包裹後再存放。
- 因為蔬果保鮮室的濕度較高，依蔬菜的量及種類不同，可能在置物盒、潤澤單元表面、食品表面有結露的情形。若在意結露的情形，請用保鮮膜包裹食品。
- 可能因食品包裝袋及容器阻塞蔬活保濕裝置，會發生更多的結露情形。請將阻塞在蔬活保濕裝置的食品包裝袋及容器移至其他地方。
- 置物盒內若留存水分，食品容易受損，請用乾布將水分擦拭。
- 將米、海苔等的乾燥食品放置在蔬果保鮮室保存時，請裝入密閉的容器（袋）後再保存於蔬果保鮮室內。乾燥食品容易吸收溼氣。

各種功能

溫度微調節（冷藏室・冷凍室）

冷藏室和冷凍室的溫度設定可以更細分為 11 個階段。

- 1 開啟下層冷凍室門
- 2 按下操作面板的 **MENU** 按鍵，顯示燈亮
顯示燈全部燈亮後，顯示目前的所有設定。
- 3 持續按住 **Fridge** 按鍵 5 秒以上，直到發出嗶聲為止
- 4 關閉下層冷凍室門
- 5 按下 **Fridge** 或 **Freezer** 按鍵，可調節各室的溫度。

按下按鍵，如下圖所示依序切換。
平常請使用在「■■■」的位置。

(□ 顯示燈亮 ■ 顯示燈閃爍 ■ 熄滅)

顯示	■	■	■■	■■	■■	■■	■■■	■■■	■■■	■■■	■■■
設定	更弱	弱	→	→	→	中	→	→	→	強	更強



解除

依照 1、2、3、4 順序操作
操作音「嗶嗶」響起，便回復到通常的調節（3 階段）。

蔬果保鮮室的溫度調節（蔬果室強）

- 1 按下操作面板的 **MENU** 按鍵，顯示燈亮
顯示燈全部燈亮後，顯示目前的所有設定。

- 2 按下 **Powerful**，「Veg」的顯示燈亮

以比平常更低的溫度來保存。（平常約 4 ~ 8°C → 「Veg」約 2 ~ 6°C）

※是冰箱周圍溫度 32°C，冷藏室、冷凍室的溫度都設定在「■■■」，且不放入食品關閉冰箱門，安定運轉時的大致溫度。

通知事項

- 為了省電，顯示在 40 秒後熄燈，直到操作解除動作，持續原本之設定。
在設定為「Veg」時，[eco 運轉顯示燈] 不點亮。



解除

按下操作面板的 **MENU**，顯示燈亮後，
再按下 **Powerful** 「Veg」的顯示燈熄滅

通知事項

- 長時間使用「Veg」功能時，含水分較多的蔬菜有可能會結凍。
- 在「Veg」模式中，設定成「節電」模式的情形時，冷卻效果會由「Veg」轉向較弱的冷卻效果。 → P.24

提示

在以下情況下，請解除「Veg」的設定。

- 茄子等對低溫較弱的蔬菜的表面呈現凹陷、變色的情形。
- 蔬果保鮮室有結露的情形。

箱門警報器

任何一個門開啟 1 分鐘以上時，會以聲音、燈光來告知冰箱門開啟。

箱門警報器功能設於冷藏室、製冰室、下層冷凍室。(上層冷凍室、蔬果保鮮室沒有箱門警報器功能)

箱門的打開時間	1 分鐘後	2 分鐘後	過了 3 分鐘以後
警報音	嗶 - (3 次)	嗶 - (5 次)	嗶 - (連續)大音量
顯示部分	閃爍	閃爍	閃爍
操作部	燈亮	燈亮	燈亮

通知事項

- 顯示部閃爍時縱使按下操作部也沒有反應。請將冰箱門關閉後再進行操作。
- 只有在「節電」模式設定時，冰箱門開啟時間達 30 秒後，門的警報器會發出聲響。但顯示部會在開啟時間 1 分鐘後閃爍。

箱門警報器及操作音的音量調節

箱門警報器及操作音可設定為更大音量，也可以設定為靜音。

購買時，設定成標準音量。

1 按下操作面板的 **MENU** 按鍵，顯示燈亮

顯示燈全部燈亮後，顯示目前的所有設定。

2 連續按著 **Fridge** 3 秒以上，直到發出設定音為止

操作音的音量可切換成「標準」「大」「關閉」。設定的切換依照此順序輪替，請依個人需求切換設定音。(參照下表)

音量	標準	大音量	關閉音量	標準
設定音	—	→ 嗶—嗶—	→ 嗶—	→ 嗶嗶

(購買時)

通知事項

- 箱門警報器或操作音，無法只調整任何一方的音量。
- 設定為不會發出聲響時，冰箱門警報器的文字顯示燈的閃爍也停止。
- 雖音量設定為「關閉」時，「製冰機清潔」的警報器也會發出聲響。→ P.27
- 當拔除電源插頭再插上插頭時，或停電後恢復供電時，冰箱門警報音則恢復到原來的標準狀態的設定。

操作面板鎖定功能

讓操作無效，是為了防止誤觸操作面板，及兒童玩弄冰箱而設計的功能。

Lock (按鍵鎖) 的顯示燈亮燈時，即使按了其他的操作部也無法切換。

1 按下操作面板的 **MENU** 按鍵，顯示燈亮

顯示燈全部燈亮後，顯示目前的所有設定。

2 持續按住 **Energy Saving** 3 秒以上，直到發出設定音為止

操作面板按鍵鎖可切換「開」或「關」。

購買時，設定成「關」(**Lock** 熄滅)的狀態。

操作面板按鍵鎖的設定	「開」(鎖定中)	「關」(解除鎖定)
「 Lock 」顯示	燈亮 Lock	熄滅
設定音	嗶—	嗶嗶

通知事項

- 拔除電源插頭再插上插頭時，或停電後恢復供電時，有可能解除操作面板的鎖定。
- 為了省電，顯示燈約 40 秒即熄滅，但該設定直到解除為止仍持續進行。

三重抗菌除臭 (冷藏室)

利用三種除臭素材的完美組合，有效地捕捉並去除冰箱內含有硫磺系、氮系、醛系、酸系等四大異味分子。

節電

「節電」模式的設定

設定成節電模式時，將各冷藏室的冷卻調弱，可達到省電目的。

開啟冷藏室門達 30 秒以上時，冷藏室的 LED 庫內燈及真空冰溫室內的 LED 庫內燈的亮度會減弱，以節省電力。

此外，長時間沒有開關冰箱門時，冰箱內部會緩慢冷卻，可以更加抑制電力消耗。

1 按下操作面板的 **MENU** 按鍵，顯示燈亮

顯示燈全部燈亮後，顯示目前的所有設定。

2 按下 **Energy Saving** 按鍵「Save」顯示燈亮

購買時，設定成節電模式「關」（熄滅）的狀態。

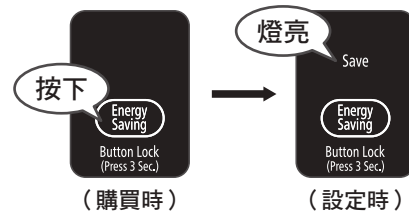

解除 按下操作面板的 **MENU** 按鍵，顯示燈亮按下

Energy Saving 按鍵「Save」顯示燈熄滅

通知事項

- 將冷卻轉換為弱的時候，冰淇淋等會變軟、冷凍食品有可能會結霜。此外讓食品冷凍的凍結時間以及製冰時間也會增長。
- 當設定為「節電」時，「Save」的顯示持續亮燈。
- 當「Save」設定中，設定「Quick」「Quick Freeze」時，則「Save」的設定會暫時解除。
- 「Save」模式與「Veg」同時設定時，冷卻從「Veg」轉變到較弱的冷卻效果。→ P.22
- 「冷凍室」「冷藏室」雙方，或任一方的溫度設定在「■」的時候，為了維持各存放室內的食品的新鮮度，冷卻效果不轉弱。

eco 運轉標誌

運轉較為安定時 **eco** 會自動亮燈，通知為省能源運轉。請作為門的開閉較少、迅速、順手使用的參考。

通知事項 **eco** 不亮燈時有可能是以下的原因所造成。

- 設置完之後馬上一次放入過多的食品時
- 很常開開關關冰箱（門開關指示燈）亮燈時
- 門夾到食品或袋子導致呈現半開狀態時
- 設定「Quick」「Quick Freezer」「Veg」時
- 冰箱周圍溫度在約 35°C 以上時

[eco 運轉顯示燈]

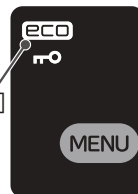

冰箱門開閉顯示燈

當冰箱門開閉次數多時，**Door** 則自動亮燈。

減少冰箱門的開關次數，盡量縮短每次開啟的時間，請做為使用時的參考。

通知事項 **Door** 亮燈後，約 5 分鐘後自動熄燈。

Door 亮燈時，**eco** 則熄燈。

[冰箱門開閉顯示]

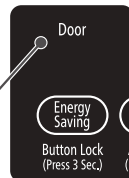

保養方法



警告

清掃時，請一定要把電源插頭從插座拔掉。

■發現骯髒時

請馬上擦掉。看不到的部分也請一年清掃一次。

電源插頭

從插座拔下電源插頭，
用乾布擦掉灰塵等。

為了防止火災或觸電 →P.4~7

一年一~二次



箱門密封墊

請以軟布沾溫水擦拭。

因為很容易髒，所以請時常擦掉髒汙。

一個月一次

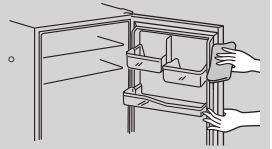

箱門表面 一個月一次

箱門表面請以柔軟的布，
沾溫水將污垢擦拭後，
再用乾布擦拭乾淨。

玻璃表面殘留有膠布黏膠時，
以塑膠橡皮擦擦拭之後，再以
乾布擦拭乾淨。

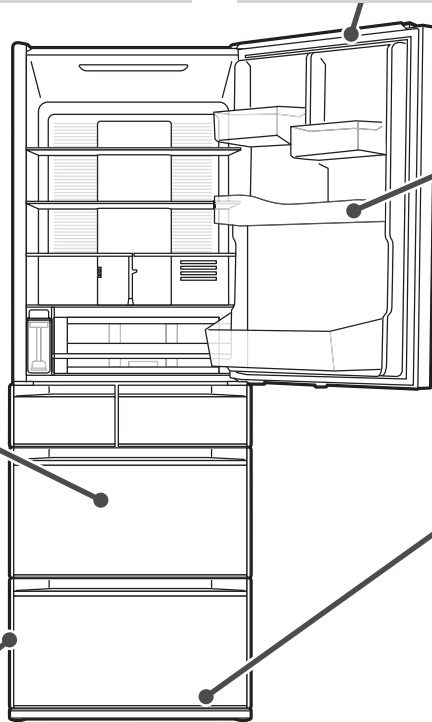
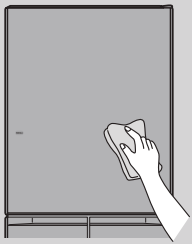

各層架 三個月一次

· 置物架

請以軟布沾溫水擦拭。

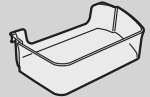

卸除方法請參閱 →P.28

液汁承接處 一個月一次

請以軟布沾溫水擦拭。

積著液汁時，
請擦乾淨。

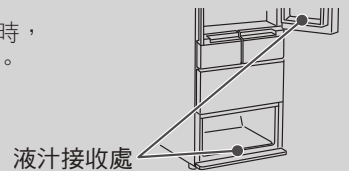

冰箱背面·地板

拆除腳座護蓋，將調節腳稍微
抬起，把冰箱往身前方向拉，
擦拭污垢。

- 面由於空氣對流的關係，容易堆積灰塵而弄髒。
若是容易刮壞的地板，則鋪上保護用的板等。
- 在意冰箱的震動音，或因濕氣而導致背面牆壁變色或髒汙時，請將冰箱設置在距離牆壁（2cm 以上）的地方。

一年一~二次

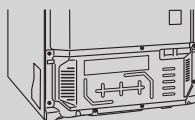

置物盒

請以軟布沾溫水擦拭。

用水清洗蔬果保鮮室下層置物盒時，請倒轉讓水滴乾，並充分擦拭乾淨。此外請勿使用牙刷、洗碗刷等長刷毛的刷子清洗。可能會造成置物盒受損及蔬活保潔裝置破損。

卸除方法請參閱 →P.29

※請勿用水清洗白金觸媒。

三個月一次

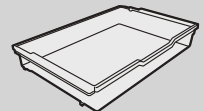

提示

●因為可能會造成箱門、塗裝面、塑膠、玻璃面受損、變色，請勿使用以下的東西。

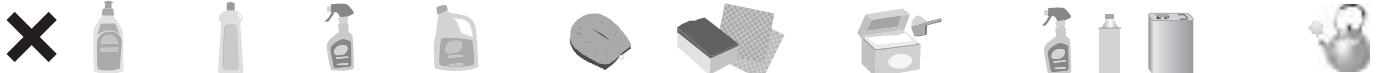

鹼性、弱鹼性的廚房洗潔劑（中性以外）、
玻璃用洗潔劑、含氯漂白劑

刷子、研磨海綿、
化學抹布

研磨粉、
粉狀肥皂

去漬油、稀釋劑、
酒精

熱水

請確認洗潔劑上「根據家庭用品品質表示法表示」的「液性」欄。

- 沾到食用油、柑橘類的果汁、食品液汁時，請務必擦乾淨。因為可能會造成附著的零件變色或割到的情況產生。
- 因置物盒或抽屜的滑動軌道接觸面上塗抹了潤滑劑，保養時請勿擦拭。（潤滑劑符合食品衛生法）
- 磁鐵裝飾或是吸盤吸附在冰箱本體的側面或冰箱門表面時，有可能會在表面留下痕跡。
- 拔除電源插頭時，會解除操作面板設定的功能，請再次確認設定。

保養方法 ~續前頁~

真空冰溫室 一個月一次

1 拉出真空冰溫盒

卸除方法請參閱 →P.28

請務必取出真空冰溫盒內食品。

2 以下的零件，請以沾溫水的軟布擦拭

※請勿使用洗潔劑。

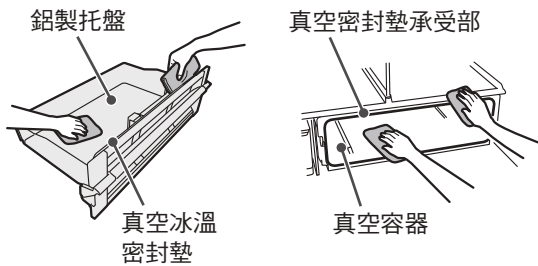

提示

- 冰箱室內的頂部（LED 庫內燈的部分），請輕輕擦拭。用力擦拭時可能造成破損。
- 真空冰溫密封墊如果使用溫水以外的洗潔劑，則有可能破損、變形、變色，無法保持真空狀態。

3 安裝真空冰溫盒

安裝方式請參閱 →P.28

如果真空冰溫室的門密封墊鬆了或是接觸不良，則無法維持真空狀態。

真空冰溫室的門密封墊太髒時

1 用柔軟的海綿等水洗髒汙的部分

※請不要使用清潔劑。

2 用乾布等擦拭水分後，讓它自然乾燥

給水槽 一週一次

1 取出給水槽，卸除水槽蓋

1 請將水槽蓋朝箭頭方向傾斜。

2 將水槽蓋的前方拿起來。

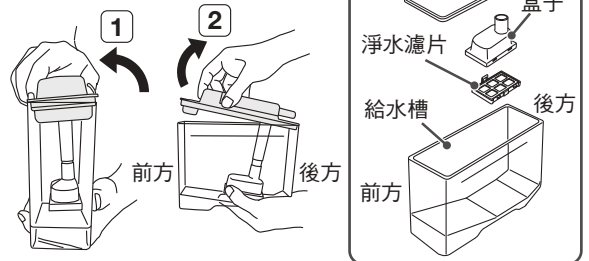

2 從水槽蓋卸除密封墊圈及盒子

盒子用拉扯的方式從蓋子上卸除。

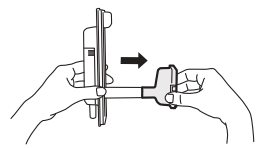

3 從盒子卸除淨水濾片

以手指拉淨水濾網，從扣勾處卸下後再卸除箱盒。

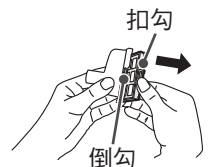

4 以水清洗給水槽各零件

以柔軟的海綿等用水洗乾淨。請不要使用洗潔劑等。

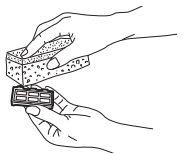

通知事項

- 請每 3 至 4 年更換一次淨水濾網。

5 將給水槽的各部零件組裝，加入水之後再安裝

蓋子和盒子請和凸部相吻合後再插入。

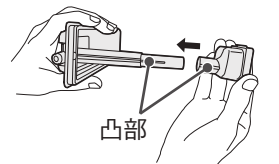

從蓋子的後方插入，請朝箭頭方向關上。

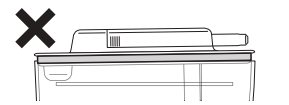
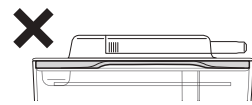
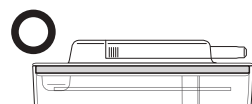

提示

自動製冰機長期不使用時，請將給水槽洗淨後，充分乾燥後，再裝入原來的位置。
(特別是淨水濾片請務必充分乾燥)

製冰機清潔

初次使用時自動製冰機一星期以上沒有使用時



警告

請勿將手放進自動製冰機的機械部分。
(當製冰盤旋轉時，會有受傷的危險)

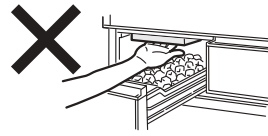

以水來沖洗製冰盤及給水管路。

準備

操作前請確認以下事項

給水槽

- 裝水至滿水線
- 超過儲水槽的安裝位置，正確的安裝。

製冰盒

- 有殘留冰塊時請清除

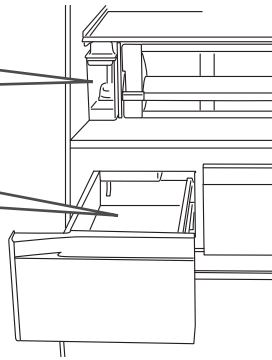

確認後，關閉所有冰箱門，
然後執行以下操作。

1

按下操作面板的 **MENU** 按鍵，顯示燈亮

顯示燈全部燈亮後，顯示目前的所有設定。

2

持續按住 **Ice Maker** 按鍵 5 秒以上，直到發出警示聲響為止

「Quick」、「On」、「Off」三個燈同時閃爍，「製冰機清潔」開始運作。(約 4 分鐘)

- 大約 4 分鐘之間，燈會閃爍、警報器會一直響。
- 「製冰機清潔」無法在中途停止。
- 「製冰機清潔」運轉時，如果打開冰箱的任何一個門時，則有可能無法正常運作。請在製冰機清潔運作結束之前不要開啟冰箱門。
- 箱門警報器即使設定成不會響的時候也會發出聲響。 → P.23



3

警報器停止後，塞住製冰盒內部的缺口部分，在製冰盒的底部鋪上乾淨的毛巾。

鋪上毛巾的主要目的是，為了防止製冰機清潔時累積的水流到製冰盒內部的缺口部分。

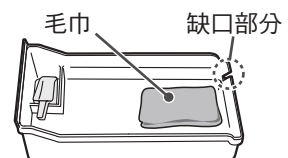

4

取出製冰盒，將製冰盒內的水擦拭乾淨後安裝在製冰室內

- 請取出擦拭水分等候的毛巾。
- 給水槽裡剩下的水，可以繼續直接使用。
- 「製冰機清潔」結束後，自動設定回「On」。

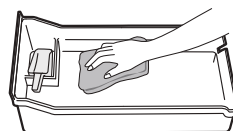

卸除組件的方法 · 安裝的方法

注意事項

- 卸除零件時，請先將放在零件上的食品移除。
- 請勿拆除此處未說明的零件。
對於未說明的零件，如要拆下清掃，請聯繫服務窗口商洽修理事宜。
- 請勿拆卸真空冰溫室、蔬果保鮮室的白金觸媒。並且請勿以水清洗。

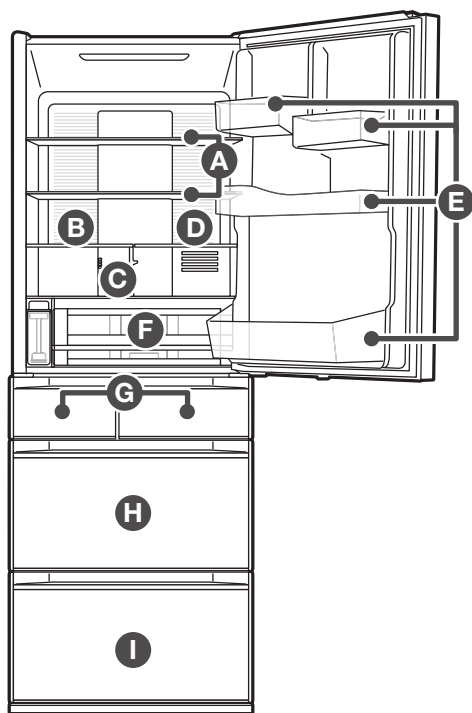

A 可調式層架上段·中段

提示 拆除棚架上層之前，請先拆除棚架中層。

- 1 把層架內側稍微抬高，往前拉出。
- 2 如圖示將棚架直立。
- 3 讓其迴轉後拆除。

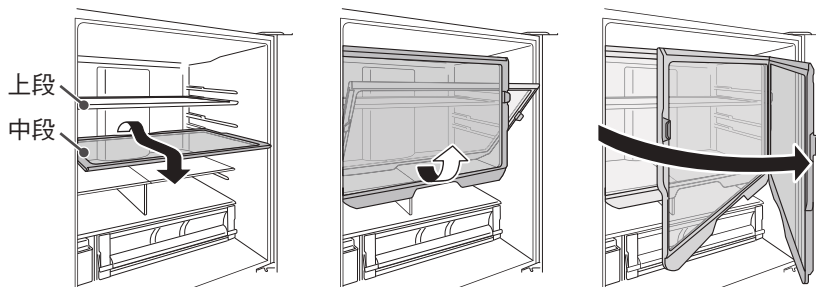

通知事項 因玻璃層架較重，安裝，卸除時請特別小心。掉落時可能會被撞傷或是因破裂而被刮傷。

B 固定層架

將層架的裡面稍微拿起，拉到面前。

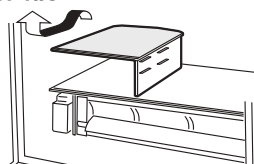

此時請先卸除可調式層架下段

C 層架隔板

- 1 拿著裡面讓它迴轉
- 2 一邊壓著裡面一邊卸除。

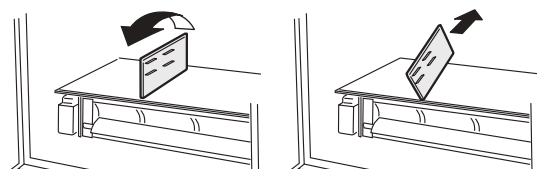

D 可調式層架下段

全體稍微拿起並卸除。

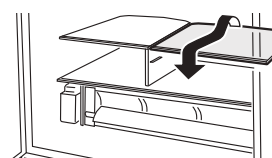

E 箱門置物架

一邊輕敲底部左右一邊提高便可卸取。
(牢固地固定)

注意事項 安裝時，請完全裝入到最底。
如果沒有確實安裝，可能會掉落造成受傷的原因。

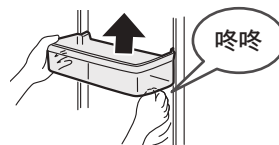

F 真空冰溫盒

卸除方法

拉出真空冰溫盒，輕輕拿起前面，斜斜的拉出。

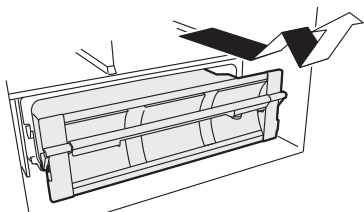

安裝方法

讓真空冰溫盒的左右突起順著真空容器的導引軌道滑動推入。最後再將把手往下扳到底鎖住。

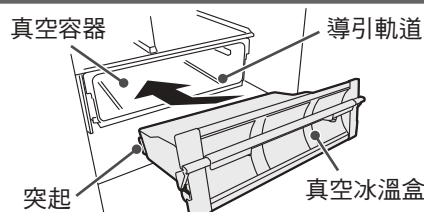

提示 安裝後請重複多次的拉出放入，確認是否已經正確安裝好。

G 製冰盒（製冰室）· 上層冷凍盒（上層冷凍室）

打開門，向前方取出。

安裝時請將盒底放在門框內之後組裝。

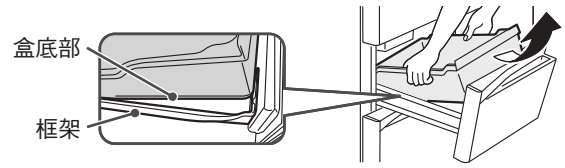

H 中層滑動盒 · 下層滑動盒（下層冷凍室）

1 打開門後，拉出中層滑動盒。

注意事項 ● 上層滑動盒無法拉出。

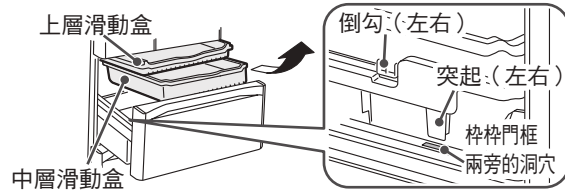

2 向上取出下層冷凍盒。

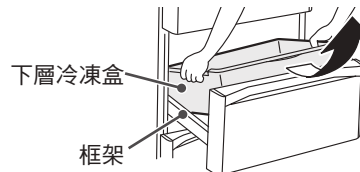

安裝冷凍盒時，請將下層冷凍盒左右突出的部分向門框兩旁的洞插入固定。請將中層滑動盒兩旁的止動裝置插入下層冷凍盒的外側。

● 請將小物品收納盒以文字「REAR」朝向內側的方式安裝。如安裝不正確，會導致開關時的異常聲音、門關閉嚴。

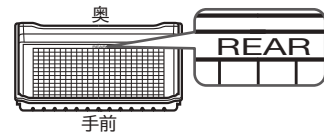

I 上層滑動盒 · 下層置物盒（蔬果保鮮室）

1 將門往身前開啟，手持兩端往上抬起，再慢慢往拉出，放在地板上。

2 將上層滑動盒拉起。

3 下層的置物盒朝身體方向向上抬起。

注意事項 ● 隔板無法拆下。

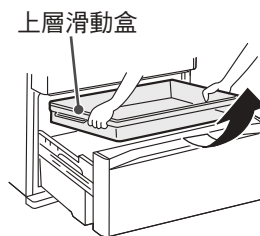
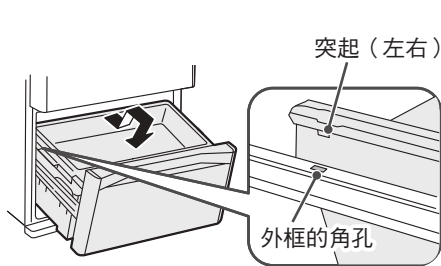

注意事項 ● 開門時請注意腳切勿靠近門。腳有可能被門夾傷。
● 請注意，蓄積的水可能從下層滑動盒背面流出。

若沒有正確的安裝時，會造成關閉時的異常聲音以及冰箱門無法關緊的原因。

提示 ● 若上層滑動盒沒有正確安裝時，可能導致滑動盒的零件破損。安裝後，請將上層滑動盒前後滑動，以確認是否正確安裝。

拉取式門的安裝方法（製冰室 · 上層冷凍室 · 下層冷凍室 · 蔬果保鮮室）

製冰室 · 上層冷凍室

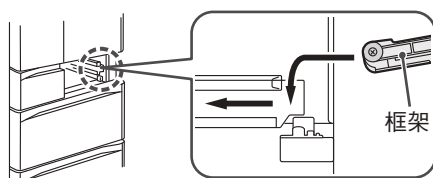

下層冷凍室 · 蔬果保鮮室

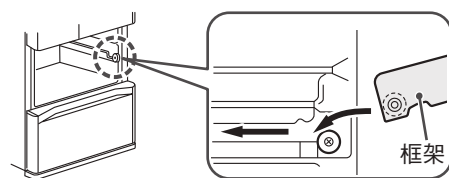

遇到問題時

在委託修理之前，請再次檢查以下幾點。

這種情況下		請確認	請依照這樣做。就是這樣的理由。
初次使用時	不冷	設置後是否未達 24 小時？	設置後至完全冷卻需要 24 小時。請將存放的食品間保留間隙，並儘量減少開閉次數，耐心等待。 此外，夏天或食品大量存放時，至完全冷卻需更多時間。
	無法製冰	設置後是否未達 24 小時？	剛設置後，因冰箱未完全冷卻，到可以製冰需要 24 小時以上。請將存放的食品間保留間隙，並儘量減少開閉次數，耐心等待。
不冷 冰淇淋變軟	不夠冷 冰淇淋變軟	食品或袋子是否被夾著，門關緊了嗎？	請去除被夾住的食物，確實關緊冰箱門。此外，食品收納時請注意食品的高度。
		是否塞入過多食品，是否一次放入了大量的食物呢？	食品之間請空開間隙存放。
		各存放室的盒子是否確實地安裝？	請正確安裝好。 →P.29
		根據冰箱的設置場所及空隙，環境狀況等，有可能會難以冷卻的情形。	請確認是否已正確安裝。 →P.8
		是否設定為「節電」模式？	請解除「節電」模式。 →P.24
		是否溫度設定在「■」？	不太容易降溫的室內，請變更溫度設定。 →P.13, 19
		在夏季等，電冰箱的環境溫度高嗎？	
		是否長時間開啟冰箱門，或冰箱門開啟頻繁？	冰箱門敞開著時，冰箱內的溫度會逐漸上升。頻繁地開閉或是長時間敞開著門的話，冰箱內的溫度會難以下降。請減少冰箱門的開閉次數及盡量縮短開閉的時間。
操作面板的顯示是否依次改變？	因為設定為店面專用模式，請解除。 →P.32		
結霜・結露	冰箱內及抽屜 框架上結霜・ 結露・冰	冰箱門或抽屜是否沒完全關緊？	關閉抽屜或冰箱門時，請確實確認是否夾到食品或包裝袋，請確實關緊。
		是否長時間開啟冰箱門，或冰箱門開啟頻繁？	當冰箱門開閉時，可能因空氣中含的水分變成霜、冰，凝結在冷凍室的壁面或零件上。請盡量迅速開關箱門，以及減少開關的次數。此時請以乾布將霜、露水擦拭。
	冰箱的外側結露	冰箱周圍的溼度是否過高？	下雨天等室內溼度高的時候會結露。此時請以乾布將露水擦拭。
		是否溫度設定在「■■■■」？	溫度設定為「■■■■」時，冰箱門表面可能會有結露情形。請將溫度設定為「■■■」。請以乾布擦拭露水。 →P.13, 19
冰箱背面及牆壁 結露	是否冰箱周圍的濕度變高、冰箱背面和牆壁間的間隙變小？	請和冷藏庫背面距離 2cm 以上。 →P.8	
冷藏室中 凝結露水	是否長時間開啟冰箱門，或冰箱門開啟頻繁？	冰箱門的開關次數頻繁時，或冰箱周圍溫度高時，壁面會起霧，在冷氣出風口附近會凝結露水。並不是故障。此時請以乾布擦拭。  凝結露水	
太冷 凍結了	太冷 凍結了	溫度調節為「■■■■」了嗎？	請設定為「■■■」。 →P.13, 19
		周圍溫度是否 5°C 以下呢？	周圍溫度低時可能冰箱內的溫度會太冷。請將溫度調節為「■」。
		是否放置在冷氣吹出口的前方？	請不要放置在冷氣吹出口前。 加蓋或以保鮮膜包裹可以防止食品結凍。

	這種情況下	請確認	請依照這樣做。就是這樣的理由。
自動製冰	完全不能製冰	是否顯示部的「Off」顯示亮燈？設定為製冰停止。	請設定「On」或「Quick」。 →P.16, 17
		是否門上的「Water」顯示亮燈？給水槽內的水變少。	請加水至給水槽內。 →P.16, 17
		是否給水槽的水變少？	水量變少時，有可能無法製冰。請試試加水加到給水槽的滿水線。 →P.16
		給水槽是否推入到超過「水槽安裝位置」線？	請將給水槽推至比水槽安裝位置更裡面。 →P.16
		除了冰塊，製冰盒中是否存放了其他物品？	設定為「On」「Quick」時，請從製冰盒中取出除冰塊之外的其他物品。
自動製冰	很難結冰	冰塊是否有局部超過最大儲冰界線？	請將冰塊整平。 →P.17
		是否頻繁地敞開門，是否一次存放了大量的食物呢？	冰箱內無法充分冷卻。請試試在冰箱內冷卻前，盡量減少開閉門。請試試盡量空開儲存食品之間的時間。
		是否冰箱周圍的溫度變低？	冬天，到可以製冰需要 4 小時以上。請儘量減少冰箱門開閉次數，耐心等待。
		是否剛從「Off」設定改為「On」？	剛改變設定後，可能需要更多時間。請儘量減少冰箱門開閉次數，耐心等待。
		食品或袋子是否被夾著，冷凍室或製冰室門是否關緊？	請去除被夾住的食物，確實關緊冰箱門。
是否設定為「節電」模式？	請解除「節電」模式。 →P.24		
自動製冰	冰塊有凸起	——	是製冰盤的溝上積水凍結了。不是異常。
自動製冰	所儲存的冰塊變小 冰塊之間粘在一起	是否積存了舊的冰塊？	舊的冰塊會變小，且會互相黏結。如果只是用冰鏟就能將冰塊分離的話，表示沒有什麼問題。
		是否頻繁地敞開門，是否一次存放了大量的食物呢？	請盡量迅速開關箱門，以及減少開關的次數。
		冷藏室門或抽屜是否沒完全關緊？	關閉冰箱門時，請確實關緊。
自動製冰	製成的冰塊很小	是否給水槽的水變少了？	當剩餘的水變少時，製冰機可能製成小的冰塊。請試試加水加到給水槽的滿水線。 →P.16
自動製冰	製成粘在一起的冰塊	——	製冰盤的溝槽部分殘留的冰塊會互相黏結。不是異常。
自動製冰	冰塊裡有白色混濁	——	是因為混在水中的氣泡被封在冰塊裡面了。
		用礦泉水製冰了嗎？	水中含有的礦物質凍結會變白而混濁，不過無害。
自動製冰	無法製冰時	——	請設定成「Off」。請參考「製冰停止」。 →P.17
箱門高低不平衡以及歪斜	左右箱門高低不平衡 箱門歪斜	設置的地點是否呈水平？	性能上沒有問題，可以照舊使用，不過介意的話，試試調整左右的調整腳。 →P.8
		是否由於地板材質太軟加上儲放物的重量使冰箱腳下沉？	冰箱本體傾斜的時候，請鋪上 1cm 以上厚的堅固的板子。

遇到問題時 ~續前頁~

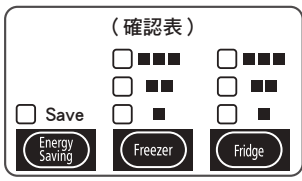
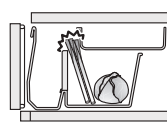
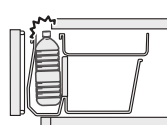
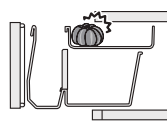
	這種情況下	請確認	請依照這樣做。就是這樣的理由。
操作面板的顯示燈正在閃爍	「Save」冷凍・冷藏的溫度調節顯示燈有三個以上正在閃爍	「Save」, 冷凍「■■■■・■■・■」及冷藏「■■■■・■■・■」共六個燈號, 請一一確認燈號的閃爍、熄燈。	請在右欄將閃爍的顯示燈做☑記號, 與客戶資訊窗口聯繫。 →P.72 詳細紀錄才能正確傳達。 
	Ice Maker 「On」顯示燈閃爍	在製冰室內除了自動製作的冰塊之外, 是否放入其他的食物或冰塊?	有可能食品等碰到製冰盤。請先將製冰室內清空, 再操作「製冰機清潔」。 →P.27
	Vacuum 「On」顯示燈閃爍	是否在維修人員檢查後所發生的?	有可能是設定在維修人員確認運轉用的模式。約 15 分鐘後恢復通常模式。使用上沒有問題。
	Quick On Off 全部呈閃爍	是否觸按 Ice Maker 按鍵長達 5 秒以上?	正在進行製冰機清潔。閃爍約 4 分鐘即停止。在顯示燈閃爍時, 請勿開啟冰箱門。
	全部顯示燈閃爍	是否冰箱門開啟中? 是否冰箱門夾住食品, 或無確實關緊?	若冰箱門開啟狀態時, 請關閉冰箱門。 若冰箱門夾住食品, 或無確實關緊, 請除去被夾住的食物, 將冰箱門確實關緊。
	操作部的顯示將依次變更	_____	這表示電冰箱正在以店面顯示模式運行。請關閉店面顯示模式。這是由於電冰箱以店面顯示模式運行時無法冷卻。打開電冰箱冷藏室的門和下層冷凍室的門。 觸摸操作面板上的 MENU, 便激活操作面板。然後, 持續觸摸 Freezer 按鍵至少 10 秒鐘, 直到聽見嗶嗶兩聲。 所有顯示燈將亮燈數秒, 表示店面顯示模式關閉。電冰箱開始冷卻。 關閉冷藏室的門和下層冷凍室的門。
蔬果保鮮室	蔬果保鮮室中凝結露水	是否存放了大量的含水份多的蔬菜?	因為蔬果保鮮室比其他保存室的濕度高, 會因蔬菜的存放量及種類, 而可能出現在蔬果保鮮室的頂部、食品的表面產生結露的情形。這並非異常現象。在意結露的情形, 建議將食品以包鮮膜包裹後再放入。此外, 結露變多時, 蔬果保鮮室的存放盒內可能會有水滴蓄積。請以乾布將蓄積的水擦拭乾淨。
		是否疏活保濕裝置被食品的外袋或容器所阻塞?	疏活保濕裝置一旦被阻塞, 很容易發生結露情形。請將阻塞在疏活保濕裝置的食品外袋或容器移至他處。請以軟布將結露擦拭乾淨。
	蔬果保鮮室的門無法關閉・蔬果保鮮室的門開啟時上層滑動盒無法回復到鎖定的位置	上層滑動盒與下層置物盒之間是否夾有食品等異物? 	請除去被夾住的異物。
	是否有寶特瓶或食品碰觸到上層滑動盒的把手部位? 	存放時請勿讓寶特瓶或食品碰觸到把手部位。	
	是否有食物被夾在上段置物盒之間? 	請去除被夾住的物品。 此外, 請勿在食品接觸到蔬果保鮮室天棚的狀態下, 硬將冰箱門關上。	

這種情況下	請確認	請依照這樣做。就是這樣的理由。
<p>真空冰溫室的密封墊是否脫離？或者密封墊是否浮起？</p> <p>真空冰溫室的密封墊與真空密封墊承受不之間是否夾著食品的包裝等、附著污垢或線頭或垃圾？</p> <p>密封墊是否緊貼著呢？</p>	<p>真空冰溫室的設定是否為「Off (關)」(非真空冰溫)？</p>	<p>請將設定改為「On」。</p> <p style="text-align: right;">➔P.15</p>
	<p>把手往上翹著嗎？</p>	<p>請將把手往下押，鎖定。</p>
	<p>把手是否有推到最終的位置，牢牢地鎖住？</p>	<p>如果沒有鎖住，則無法啟動真空機能。請把真空冰溫盒推壓到底之後，將把手往下推押到底，確實地鎖緊。</p>
	<p>真空冰溫室的密封墊是否脫離？或者密封墊是否浮起？</p>	<p>請將真空冰溫室的密封墊的突起處和滑動盒的洞相吻合後安裝。為了不要讓密封墊浮起請放到最裡面。</p>
	<p>真空冰溫室的密封墊與真空密封墊承受不之間是否夾著食品的包裝等、附著污垢或線頭或垃圾？</p>	<p>若食品包裝等異物被夾住時，請除去異物。如果真空冷藏的密封墊髒了，請進行清潔。</p> <p style="text-align: right;">➔P.26</p>
	<p>密封墊是否緊貼著呢？</p>	<p>若密封墊緊貼著，則無法維持密封狀態。若緊貼時，請將其剝離。因為左右面及下面無法看清楚，請將真空冰溫盒拆卸後進行確認。</p> <p style="text-align: right;">➔P.28</p> <p>若密封墊髒污時，請清潔乾淨。</p> <p style="text-align: right;">➔P.26</p>
<p>不知道是否在真空</p>	<p>打開真空冰溫室時，是否發出聲音？</p>	<p>真空幫浦啟動後，至達到真空狀態約需 3 ~ 4 分鐘。開閉後，請等待 4 分鐘以上。</p> <p>打開時如有「咻」的聲音，便是正常。</p>
<p>把手不能上鎖</p>	<p>真空冰溫室的密封墊部分及真空冰溫盒的裡面是否有食品等被夾著呢？</p> <p>是否正確地安裝真空冰溫盒？</p>	<p>若有被夾住請除去異物。</p> <p>請依照「安裝的方法」所指示安裝真空冰溫盒。</p> <p style="text-align: right;">➔P.28</p>
<p>真空冰溫室的周圍發出「呲～」的聲音和振動</p>	<p>是否真空冰溫盒夾住物品，或真空冰溫室的密封墊髒了？</p> <p>是否將把手往下推押到底，確實地鎖緊？</p>	<p>是真空幫浦的運作聲音。如夜間等介意有聲音的時候，可以停止真空幫浦的運作。真空冰溫室請變更設定為「Off (關)」</p> <p style="text-align: right;">➔P.15</p> <p>若食品包裝等異物被夾住時，請除去異物。請清洗髒污的真空冰溫室的密封墊。</p> <p style="text-align: right;">➔P.26</p> <p>請將把手往下推押到底，確實地鎖緊。</p>
<p>真空冰溫室的內部或真空冰溫盒的周邊有水滴或結霜，冰</p>	<p>是否存放了含水份多的食物？</p>	<p>因為真空冰溫室是密封的狀態，如果存放水分較多的食品時，會在室內凝結成露水或結成霜。水分較多的食品建議以保鮮膜包覆。如果附著了水滴或結霜，請用沾了溫水的布擦拭。</p>

真空冰溫室的問題

遇到問題時

遇到問題時 ~續前頁~

這種情況下	請確認	請依照這樣做。就是這樣的理由。
有異味	有塑膠味	是因為在冰箱內使用了多數的塑膠零件，不過，充分冷卻後自然就會慢慢減輕。不是異常。
	冰塊有異味	給水槽・淨水濾片骯髒嗎？冰塊舊嗎？ →P.26, 27
		由於自來水中的氯元素凝縮，氯的氣味會很重。
冰箱內有異味	是否直接地儲放了氣味重的食品呢？ 脫臭機能不能完全去除所有的氣味。 請用保鮮膜等密封後儲放。	
冰箱發熱	電冰箱的側面發熱 箱腳底下吹出暖風	為了讓冷卻裝置運作時所產生的熱氣向外排而會發熱。剛安裝後或是夏季，可能會有50~60°C，在安全上及性能上沒有問題，但請勿以手觸摸。
聲音不對	冰箱發出的聲音嘈雜	地板是否有彎曲？ 請鋪上厚度 1cm 以上的牢固板子後，將冰箱設置在板子上。 →P.8
		冰箱是否靠著牆或家具？ 請在冰箱的周圍空出間隙安裝。
		冰箱是否充分冷卻？ 購買後，剛開始使用等冰箱還未冷卻時，箱門開閉頻繁時，周圍的溫度高時，由於壓縮機高速運作，可能會感覺到聲音大。
		是否設定為「Quick」「Quick Freeze」？ 設定在「Quick」「Quick Freeze」時，壓縮機及風扇馬達會加速運轉，聲音會變大。
	運作音長	因正處於省能源運轉狀態，壓縮機慢慢地運轉，所以可能運轉聲音會維持較久時間。
有時聲音變大	因應冰箱內的溫度變化，而變更運轉的強度，所以有時會發出較大的聲音。	
其他 例如聽到這樣的聲音時	像流水的聲音（揪囉揪囉） 像碰撞的聲音（叩吱叩吱） 像沸騰的聲音（啾啾啾） 像燒肉的聲音（唧~） 是電冰箱的冷媒流動聲・融霜時的水流聲蒸發聲。 不是異常。	
	像摩擦的聲音（啤唏） （“叩動”聲） 是冰箱的溫度變化時，或真空冰溫室的氣壓變化時，部件的摩擦聲。 不是異常。	
	像什麼被卡著的聲音（嗚嗚） 像呻吟的聲音（撲~） 像剛關門時的聲音（呸~） 是控制冰箱內溫度的電氣部件或真空幫浦的運作聲。 不是異常。	
	自動製冰機的聲音 （啾~） （嘎啦嘎啦） （咯囉咯囉） 是冰塊從自動製冰機的製冰盤掉落時，或是製冰盤裡給水時所發出的聲音。 不是異常。 按下  按鍵，讓其顯示為「Off」時，就不會發出聲音。 →P.17	
	時常有的聲音（卡嗒卡嗒） 為了冷卻冰箱內開始運作時的聲音。 不是異常。	

這種情況下	請確認	請依照這樣做。就是這樣的理由。
觸碰到機體會感覺到微量的電流	——	電冰箱會帶有靜電，安全上沒有問題。
電視機・收音機等發生有雜音・映像的花亂	——	是從電冰箱發出的微弱電磁波的影響。 要安裝時請遠離電視機、收音機、門鈴對講機等。 請在遠離天線等的地方連接電源。
塑膠零件上有像傷痕一樣的細線	——	是塑膠成型時發生的樹脂流痕。透明的部件會特別顯眼，強度上沒有問題，不會破裂。
箱門面或側面・頂面上有波紋或歪扭	——	冰箱的製造工程上，會發生輕微的波紋或歪扭。根據照射方向及亮度等會感到顯眼，這不是異常現象，在性能上也沒有問題。
箱門內側有小的洞	——	<p>這個洞是在冰箱製造過程中，填充斷熱材料時為了讓內部的空氣往外散所挖的洞。不是損傷也不是異常情形。</p>  <p>※因商品不同，可能貼著貼紙，使用時請勿將貼紙撕下。</p>
停電了	——	在到恢復之間，請減少箱門的開閉，避免重新再存放食品。 停電後恢復供電時，請確認操作部位的設定。
長時間不使用冰箱	——	請將冰箱內的東西全部清出。 請先將電源插頭拔除，再進行冰箱內、自動製冰機的清潔。 所有的門打開讓其乾燥 2～3 天。 →P.25～27
除霜	——	此電冰箱自動除霜，不需要操作。溶解了的水會積在蒸發盤上，自動蒸發。
移動・搬運	——	請參閱「移動・搬運的事前準備（搬家時）」。 →P.36
玻璃破裂 (冰箱門玻璃・玻璃層架)	——	請勿觸碰破碎的玻璃，立刻聯絡購買的銷售店，委託修理。
關閉冰箱門時， 其他門則自動開啟	——	是否關閉冰箱門時用力過猛呢？ 因為各冷藏室的冷氣通路是相連通，有可能因為關閉冰箱門時的風壓，而導致其他門瞬間開啟。
冰箱門關閉後，馬上要再 打開時，感覺很重	——	冰箱門是否長時間處在開啟狀態呢？ 在冰箱內的空氣瞬間被冷卻，此時短時間內壓力變低所造成的現象。 請勿長時間開啟冰箱門，減少一直開閉的次數。
特別在意震動音，因濕氣而 導致背面牆壁變色・髒汙時	——	請將冰箱設置在離背面牆壁（2cm）以上。 →P.8
小蒼蠅等昆蟲飛入 冰箱時	周圍是否有蒼蠅？	敬請保持周邊環境乾淨。 請放置蒼蠅忌避物品或補蠅器。
	冰箱內是否存放氣味強烈的食品？	為了避免氣味吸引蒼蠅，請將食品加蓋或以保鮮膜包覆。
	箱門是否長時間開啟？	請盡量在拿取食品後馬上關上箱門。

其他

遇到問題時

移動・搬運的準備（搬家時）

- 1** 將食品及冰塊取出
- 2** 將給水槽・製冰盤的水倒掉
拆下給水槽，進行製冰機清潔。 (→P.27)
- 3** 拔除電源插頭
要搬動之前拔除即可。
- 4** 拆除冰箱腳座護蓋，將調整腳升高 (→P.8)
- 5** 以膠布將冰箱門・電源線固定
- 6** 移動・搬運時請鋪上保護用的鋪墊或布
防止刮傷地板、或冰箱內部殘留水流至地板。
- 7** 在背面下面的排水口下面鋪上布等，將冰箱往後傾倒，讓水流出

舊布等
- 8** 搬運時請握住搬運把手搬運，並請 2 人以上進行搬運輸
運輸時請勿將冰箱橫放。
(冰箱故障的原因)

- 9** 請依照「使用前的準備」的指示進行設置 (→P.8, 9)

另購零件

■以下零件更換時，請務必向經銷店指明冰箱的型號，購買專用的零件。

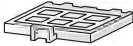
這種情況時	商品名	型號	商品型號	
冰塊有味道時 ●可能淨水濾片老舊、髒污。 (約 3 ~ 4 年更換一次)	自動製冰用淨水濾片	全機種通用	RJK-30	

CONTENTS

BEFORE USE

SAFETY PRECAUTIONS	38
BEFORE USE	42
Setting up the refrigerator	42
PARTS AND FUNCTIONS	44
Name of each compartment, temperature guide, and examples of stored food	44
Functions of the control panel	45

GENERAL USE

REFRIGERATOR COMPARTMENT	46
Parts	46
Preserving foods at lower temperatures (Using the Moisture Cooling function)	46
Adjusting the temperature of the refrigerator compartment ..	47
Adjusting the height of shelves	47
VACUUM COMPARTMENT	48
Stored foods	48
Changing the vacuum compartment setting	49
When opening/closing the door of the Vacuum Case	49
ICE COMPARTMENT (Automatic ice maker)	50
Making ice	50
Amount of ice that can be stored and time required to make ice ..	51
Making ice quickly	51
Turning the ice maker off	51
Water supply indicator	51
When the "On" indicator blinks, or the "■■■■" and "■" freezer indicators and the "■" fridge indicator blink	51
FREEZER COMPARTMENTS	52
Type of foods that can be stored / Notes on using the freezer compartments ..	52
Adjusting the temperature of the freezer compartments	53
Quickly freezing foods (Quick Freezing)	53
VEGETABLE COMPARTMENT	54
Type of foods that can be stored / Notes on using the vegetable compartment ..	54
Tips for storing vegetables	55
VARIOUS FUNCTIONS	56
Detailed temperature adjustment (refrigerator and freezer compartments) ..	56
Adjusting the temperature of the vegetable compartment (setting the cooling mode to "Veg")	56
Door alarm	57
Adjusting the volume of the door alarm and control panel ..	57
Locking the control panel	57
Triple-power deodorizing function (refrigerator compartment) ..	57

SAVING ENERGY	58
Using "Energy Saving" mode	58
"eco" indicator	58
"Door" indicator	58

MAINTENANCE

MAINTENANCE	59
Power plug / Door gaskets	59
Door surfaces / Shelves / Containers and trays	59
Back and bottom surface of the refrigerator / Drip pan ..	59
Vacuum compartment	60
Water supply tank	60
Cleaning the ice maker	61
HOW TO REMOVE/INSTALL PARTS	62
Upper and middle height-adjustable shelves	62
Fixed shelf	62
Shelf partition	62
Lower height-adjustable shelf	62
Door shelves	62
Vacuum compartment	62
Ice container (ice compartment) and upper freezer container (upper freezer compartment) ..	63
Containers for small and large items (lower freezer compartment) ..	63
Upper and lower containers (vegetable compartment) ..	63
Drawer doors	63

TROUBLESHOOTING

TROUBLESHOOTING	64
Start of use	64
Cooling power	64
Frost or condensation	64
Excessively cold	64
Automatic ice maker	65
Uneven refrigerator doors	65
Blinking indicators on the control panel	66
Vegetable compartment	66
Vacuum compartment	67
Strange odors	68
Overheating of the refrigerator	68
Strange sounds	68
Other	69
Moving or transporting the refrigerator	70
AVAILABLE PARTS	70
NOTES ON NON-CFC REFRIGERATORS/ GUIDE ON TOTAL STORABLE WEIGHT	71
AFTER-SALES SERVICE	72

BEFORE USE

GENERAL USE

MAINTENANCE



TROUBLESHOOTING

SAFETY PRECAUTIONS



Be sure to follow these precautions.

Failure to follow these safety precautions might result in injury or damage to property.

■ The following labels are used to indicate the severity of injury or damage that might result if precautions are ignored.

	WARNING	Indicates hazardous or unsafe practices that might result in severe personal injury, damage to property, or death.
	CAUTION	Indicates hazardous or unsafe practices that might result in personal injury or damage to property.

■ The following symbols are used to indicate actions that are prohibited and those that are required.

	Indicates prohibited actions.
	Indicates required actions.

■ This refrigerator uses flammable refrigerant. The following symbol is used to indicate guidelines related to the refrigerant.

	Indicates precautions related to the flammable refrigerant.
---	---

WARNING

Installing the refrigerator

- **To avoid a hazard due to instability of the appliance, it must be fixed in accordance with the instructions.**
- **Take measures to prevent the refrigerator from falling over, for example, in the event of an earthquake.**
If the refrigerator falls over, it could cause injury.



- **Do not install the refrigerator where it might get wet.**
 - If the refrigerator gets wet, the electrical insulation of the refrigerator might become impaired, leading to an increased risk of electric shock or fire.

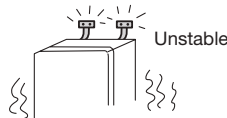

Power cord and power source

- **Use only rated AC power sources. Choose a power source suitable for the refrigerator's electrical specifications.**
Use an outlet with a rating of 10A or higher. Do not plug other appliances into the same outlet, as this might cause the power cord to heat up and lead to fire.

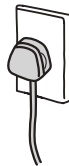

- **When positioning the appliance, ensure the supply cord is not trapped or damaged.**
Do not cut, modify, twist, overextend, bind (or tie up), or forcefully bend the power cord. In addition, ensure that the cord does not touch any hot objects or surfaces, does not get caught under heavy objects, and is not wedged between the refrigerator and the wall. Using a damaged power cord might cause electric shock, short-circuiting, or fire. If the supply cord is damaged, it must be replaced by the manufacturer, its service agent or similarly qualified persons in order to avoid a hazard.

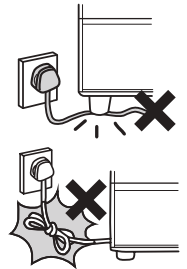

- **Firmly insert the power plug into the outlet so that the power cord is oriented downward.**
If the power cord is oriented upwards, this might strain the cord, resulting in overheating or short-circuiting, which can in turn cause electric shock or fire. These risks also apply to cases where the power plug is not inserted firmly.

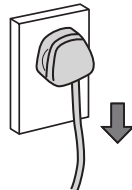

- **Periodically clean the power plug.**
Dust on the plug might impair the electrical insulation and lead to fire. Unplug the power cord, and wipe the plug with a dry dishcloth.



⚠ WARNING

Power cord and power source



- **Ensure your hands are dry before you handle the power cord.**
 - Handling the power cord with wet hands might result in electric shock.



- **Unplug the power cord before performing maintenance on the refrigerator. Performing maintenance while the power cord is plugged in might result in electric shock or injury.** (→ P.59)

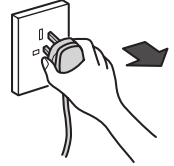

- To unplug the power cord, firmly grasp the plug. Do not pull on the power cord itself.

Using the refrigerator



- **Ensure water does not splash on or spill in the refrigerator.**
 - Water might impair the electrical insulation of the refrigerator, leading to electric shock or fire.

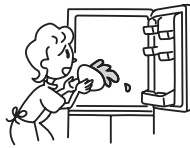

- **Do not put liquid containers on top of the refrigerator.**

- Liquid spilling from such containers might impair the electrical insulation of the refrigerator, leading to electric shock or fire.



- **Do not store flammable substances in the refrigerator.**
 - Flammable substances (such as benzene, ethanol, LP gas, paint thinner, and certain glues) might ignite, causing an explosion.

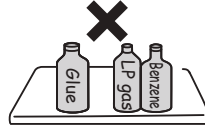

- **Do not store drugs, chemicals, or substances used for research or experiments in the refrigerator.**

- Do not use this refrigerator to store items that require precisely controlled conditions.



- **Do not use flammable sprays near the refrigerator.**
 - Use of such sprays near the refrigerator might result in fire or injury.



- **Do not put items on top of the refrigerator.**

- Items on top of the refrigerator might fall when refrigerator doors are opened or closed, resulting in injury.



- **Do not step on, climb onto, or hang off of the refrigerator doors or any compartments.**

- Such actions might lead to injury if the refrigerator tips over or if hands or other body parts get caught in the refrigerator doors.



- **Do not remove the cover of the interior LED light.**

- If the interior light is damaged, contact a customer service center to request repair. Do not attempt to repair the light by yourself, as this might result in injury.

- **Do not apply excessive force to the refrigerator doors, for example, by forcing open the refrigerator doors or leaning against the doors while they are open.**

- **Do not strike or apply excessive force to the glass doors.**

- **Do not put power strips or portable power supplies behind the refrigerator.**



- **Do not touch the mechanical parts of the automatic ice maker.**
 - Touching these parts might result in injury.



- **Children should be supervised to ensure that they do not play with the appliance.**
- **Cleaning and user maintenance shall not be made by children without supervision.**

⚠ WARNING

Regarding the flammable refrigerant (Be careful of the following related to the use of flammable gas.)



- **Do not scratch or damage the main body of the refrigerator by using a screwdriver or sharp object.**

The refrigerator uses flammable refrigerant.

Damage to the main body of the refrigerator might cause the pipe containing the refrigerant to leak, leading to fire or an explosion.

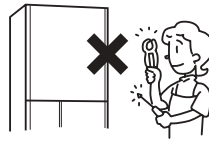

- **Do not attempt to defrost the refrigerator by using any means other than those recommended in this manual.**
- **Do not use mechanical devices or other means to accelerate the defrosting process, other than those recommended by the manufacture.**
- **Do not use electrical appliances inside the refrigerator.**
 - If the refrigerant leaks, this might lead to fire or an explosion.



- **Do not damage the cooling circuit of the refrigerator.**

If you damage the cooling circuit, open a window to ventilate the room, and avoid using fire and electrical appliances. Keep your distance from the refrigerator, and contact a customer service center to request repair.

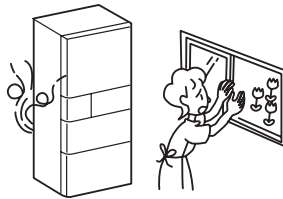

- **Leave space around the refrigerator, and ensure the room is well ventilated when you install the refrigerator.**

→ P.42

If the refrigerant leaks, this might lead to fire or an explosion.

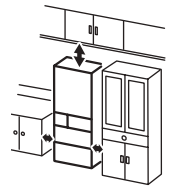

- **To dispose of this refrigerator, consult with a sales representative regarding proper disposal methods.**

If the cool leaks, this might lead to fire or an explosion.



- **Do not remove warning labels that include the symbol on the left from the compressor or the refrigerator.**

- **Handling, service and installation of used flammable refrigerant shall be done by Hitachi authorized service companies or service engineer only.**

In case of emergency



- **If the refrigerator is malfunctioning, unplug it.**

Continuing to use the refrigerator while it is malfunctioning might result in electric shock or injury.

- To unplug the power cord, firmly grasp the plug. Do not pull on the power cord itself.

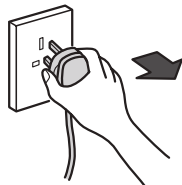

- **Do not disassemble, repair, or modify the refrigerator by yourself.**

Such actions might lead to fire or malfunction, resulting in injury.

- If the refrigerator needs to be repaired or disassembled, consult with a sales representative.



- **In the event of a gas leak, open a window to ventilate the room. Do not touch the refrigerator.**

• Using the refrigerator without ventilating the room might result in fire or injury.



Disposing of the refrigerator



- **Before disposing of the refrigerator, remove the door gaskets to avoid the risk of an infant or a child becoming trapped inside.**



CAUTION

Moving the refrigerator



- **Do not move the refrigerator by using its wheels, as this might damage the floor.**

- Lay a protective sheet or cloth along the path where the refrigerator will be moved, to prevent the floor from being damaged.

- **If you are moving the refrigerator by using a crane, do not attach the crane to the refrigerator door handles.**

- **Ensure that the back and sides of the refrigerator do not knock into anything during transport.**

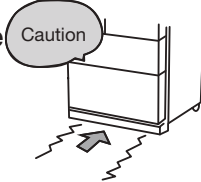

- **When moving the refrigerator, grasp the handles for moving the refrigerator.**

If you hold other parts of the refrigerator, your hands might slip.

- For safety reasons, you will need at least two people to move the refrigerator.
- Carry the refrigerator with its doors facing up as shown in the figure.
- Use tape to secure the power cord so that it does not drag or hang down.

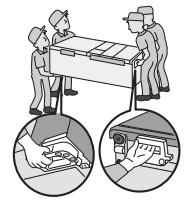

Using the refrigerator



- **Do not overload the door shelves.**

- If large bottles or other items are forcibly packed into the door shelves, they might fall out, causing injury.



- **Do not store glass bottles or jars in the freezer compartments.**

- When their contents freeze, the bottles or jars might crack or shatter, causing injury.

- **When opening or closing a refrigerator door, ensure that your fingers or hands do not get caught between the door and other parts of the refrigerator, such as an adjacent open door.**

- **When closing a refrigerator door, do not hold onto parts of the refrigerator other than the door handle.**

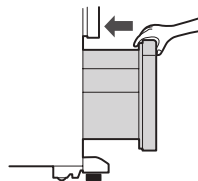

- **When opening the vegetable compartment, take care not to get your feet caught between the compartment and the floor.**

- Open this compartment with care, as you might hit your foot, resulting in injury.

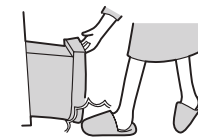

- **Do not put your hands or feet under the refrigerator.**

If you put your hands or feet under the refrigerator (for example, during cleaning), you might cut yourself on some metal parts or otherwise injure yourself.

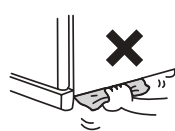

- **Ensure food and other stored items do not protrude from their compartments or over the edges of shelves.**

- Bottles or other items might fall out, causing injury.

- **Do not open or close refrigerator doors while another person is using the refrigerator.**



- **When opening or closing a door or compartment while another door or compartment is open, be careful not to pinch your hands or fingers between the doors or compartments.**

- **Do not touch food or any items (including containers and trays) inside the freezer compartments with wet hands.**

- Touching such items (especially metal items) with wet hands might cause injury or frostbite.

- **Do not eat food that smells strange or that has changed color.**

- Eating spoiled food might cause sickness or serious illness.

- **Do not put hot items on glass shelves.**

- **Do not strike or apply excessive force to the glass shelves. (The glass shelves might crack or shatter, causing injury.)**

- **Do not open or close refrigerator doors with excessive force, as this might cause food or other items to fall.**



- **Ensure that the refrigerator doors are completely closed.**

If doors are not closed completely and left slightly open for an extended period of time, condensation or frost might form and, as a result, water might drip from the refrigerator onto the floor.

- **When opening or closing a refrigerator door, ensure that your fingers or hands do not get caught between the door and other parts of the refrigerator, such as an adjacent open door.**

- **Be careful when inserting and removing the glass shelves as they are heavy.**

- **If you hear an odd sound or find residue (such as powder) caused by abrasion, immediately stop using the refrigerator and contact our customer service center to request inspection.**

BEFORE USE

Setting up the refrigerator

1 Choose a location for the refrigerator.

- Ensure the floor is sturdy and level.
If the refrigerator is to be placed on a surface that might deform or discolor (such as carpeting, flooring, or vinyl), install the refrigerator on top of a board that is at least 1 cm thick.
- Ensure that the refrigerator is not exposed to excessive heat or direct sunlight. Installing the refrigerator in a location exposed to heat or sunlight might degrade its cooling power and result in higher electricity bills.
- Choose a location with low humidity and good ventilation.
This helps prevent rusting and condensation.
- Do not install the refrigerator near TVs.
Proximity to this refrigerator might interfere with the sound and display of TVs.

- Leave space around the refrigerator for ventilation.
(See the figure on the right.)

Note: The dimensions of the middle part of the side of the refrigerator might be larger than the indicated dimensions. When choosing where to install the refrigerator, ensure that there is enough space around the refrigerator.

Note: If you are worried about the loud vibration noise, condensation behind the refrigerator due to high humidity, or the discoloration or staining of the wall or wallpaper behind the refrigerator, leave **at least 2 centimeters** of space between the refrigerator and the wall.

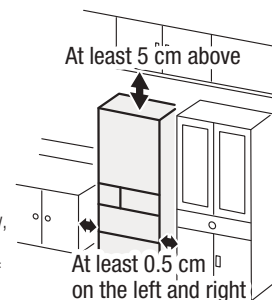

2 Install the refrigerator.

1 Remove each leg cover by pulling it toward you.

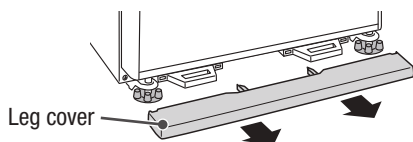

2 Turn the left and right adjustable mounts until they touch the floor, and ensure that the left and right doors of the refrigerator are level.

If the doors are uneven, turn the adjustable mounts approximately 1 time for every 1 mm of difference. To adjust an adjustable mount, fit the provided tool securely around the mount and then turn the mount.

■ The right side door is lower.

■ The left side door is lower.

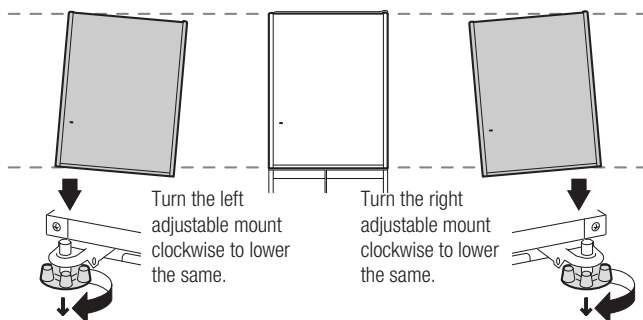

- Excessively turning an adjustable mount may cause it to detach.

The shape of the adjustable mounts differs depending on the production time.

If the adjustable mount is shape B, it can be adjusted using a Phillips screwdriver.

Please check the shape of the adjustable mounts and adjust them accordingly.

If the adjustable mount is shape A



Cannot be adjusted using a Phillips screwdriver.

If the adjustable mount is shape B

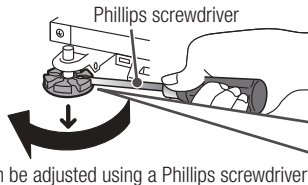

Can be adjusted using a Phillips screwdriver.

- Please use the Phillips screwdriver when turning the adjustable mount, and be careful not to scratch the floor.

3 Attach each leg cover by inserting the tabs into the mounting holes.

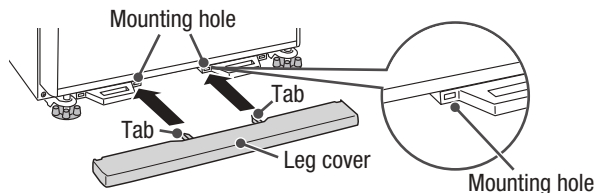

Note

- Packaging specifications may vary depends on production time, but this does not affect the quality.
- Depending on the strength and type of the floor material, and the weight of the food, the door may lower several days later (about 5 days). In this case, adjust the doors to be parallel again.
- If the place where the refrigerator is installed is not horizontal or the floor material is soft, there may be a height difference between the left and right doors of the refrigerator.
This will not affect the performance of the refrigerator. However if you would like to level it, adjust the doors to be paralleled by following the procedure on the left.
- Correcting any left / right lean and lifting slightly the front side of the refrigerator until the door can be closed easily and completely.
- When you release your hand from a refrigerator door with the door open, the door may move. But this is normal.

Recommended size of Phillips screwdriver

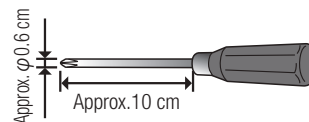

Insert the Phillips screwdriver securely into the groove of the adjustable mount and then turn it.

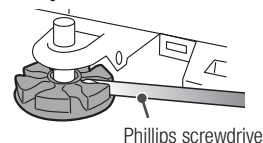

3

Clean the interior of the refrigerator. → P.59-61

- Wipe down the interior surfaces of the refrigerator by using a wet sponge or dishcloth, and then dry the interior surfaces by using a paper towel or dry dishcloth.
- Wash the water supply tank and water filter.

Notes:

1. Do not wipe off the lubricant on the slide rails of the drawers or on the surfaces in contact with the slide rails. (This lubricant conforms to Japan's food hygiene law.)
2. When you first start using the refrigerator, you might notice a faint plastic odor. If you are bothered by this odor, ensure that the room is well ventilated to allow the odor to dissipate. (The odor will gradually disappear.)

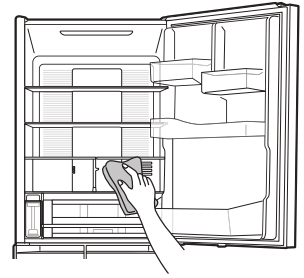

4

Plug in the power cord.

You can plug in the power cord at any time after the refrigerator is installed.

Do not plug other appliances into the same outlet. (Current: 220V to 240V, rating: 10A or higher)

- To prevent the cord from heating up, ensure the power plug and cord are not wedged between the back of the refrigerator and the wall.

The refrigerator begins to cool (After cooling the Refrigerator Compartment, the other storage compartments (the Ice Compartment, Freezer Compartment, Vegetable Compartment) are cooled).

- Depending on the ambient temperature and whether food is stored in the refrigerator, it might take about **4 hours** for the refrigerator to become sufficiently cold. In the summer or during other hot periods, it might **take 24 hours or even longer**.
Do not put ice cream, uncooled foods, or perishable food in the refrigerator before the refrigerator becomes sufficiently cold.
- Clean the ice maker before using it for the first time. → P.61
- After the refrigerator is sufficiently cold, a series of ice-making operations will automatically start. **(If you are using the ice maker for the first time, it might take 24 hours or longer to make ice.)**
- In some instances, such as if the interior of the refrigerator is already cold, cooling might not start for about 10 minutes after you plug in the power cord.

NOTES

- If you want to install the refrigerator in an area where the refrigerator might be exposed to sulfide gas (such as in a region with hot springs), you might need to apply anti-rust treatment to the piping. Please contact a sales representative in advance. The product warranty does not cover problems caused by exposure to sulfide gas.
- After you plug in the power cord, you will hear noise from the refrigerator, indicating that it is preparing for operation. **You might also hear a louder noise from the compressor or the fan until the refrigerator becomes sufficiently cold.**
- Do not remove the sticker on the back of the refrigerator, or the plastic parts near the bottom on either side of the refrigerator.
- If you attach magnets or suction cups to the refrigerator doors or other parts, the magnets or suction cups might leave a mark on the surface of the refrigerator.
- Photos, cards, or other paper materials on the refrigerator door might absorb moisture that condenses as a result of high humidity.

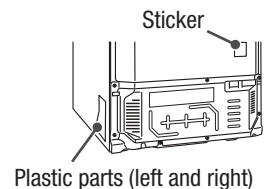

PARTS AND FUNCTIONS

Name of each compartment, temperature guide, and examples of stored food

Refrigerator compartment → P.46
 Shelf: About 2°C to 6°C Pocket: About 2°C to 9°C

Daily foods

Vacuum compartment → P.48
 About -2°C to 0°C

Ice compartment
 → P.50
 About -19°C to -17°C

Ice container
 Ice made by the ice maker

Upper freezer compartment
 → P.52
 About -19°C to -17°C

Lower freezer compartment
 → P.52
 About -20°C to -18°C

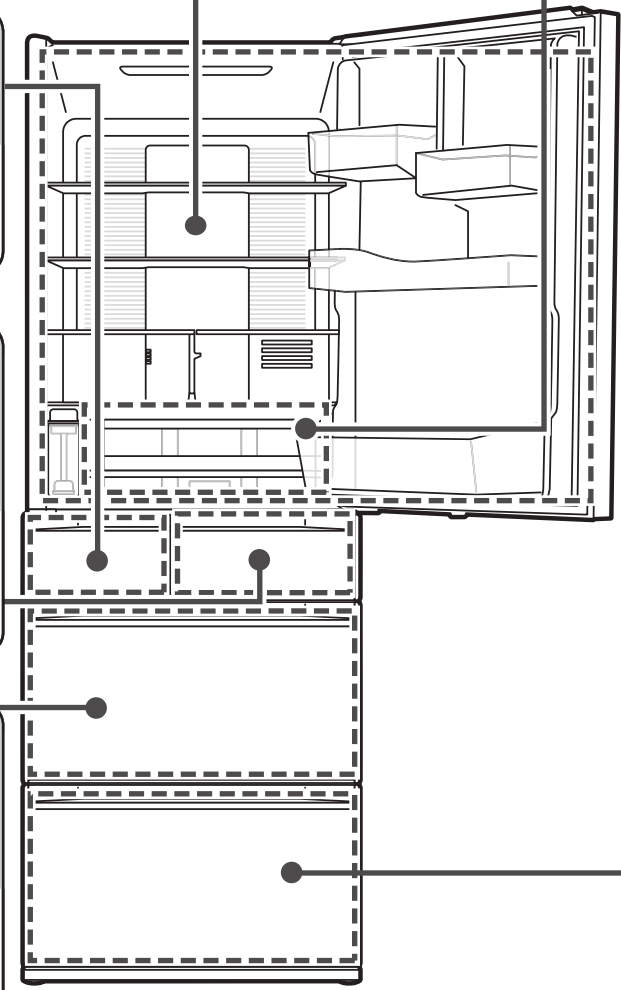

Vegetable compartment
 → P.54

Upper/Lower container : About 4°C to 8°C

Upper container	Lower container
Small fruits and vegetables, and loose produce	Leafy vegetables (spinach, Japanese mustard spinach, etc.), bulky vegetables (cabbage, lettuce, etc.)

Space for tall items : About 4°C to 9°C

Space for tall items

Long vegetables, bottled drinks, etc.

- Note: The above estimates assume the following.
1. The ambient temperature is 32°C.
 2. The temperature setting for both the refrigerator and freezer compartments is set to "■■■".
 3. Nothing is stored in the refrigerator.
 4. The doors of the refrigerator are closed and the temperatures of each compartment are allowed to stabilize.
 5. The "Veg" setting is off.
- ※The temperature may vary depending on food storage conditions, door opening and closing, etc.

Tip for storage

- Leave space between items stored in the refrigerator.
- We recommend that you wrap odorous foods before storing them in the refrigerator.
- Refer to the guide on the total weight of food that can be stored on each shelf or in each container. → P.71

Functions of the control panel

The control panel consists of a display area and buttons for operating the control panel. The control panel display is normally off, and can be turned on by touching the **MENU** button. Touch the buttons for operating the control panel to change the settings of the refrigerator.

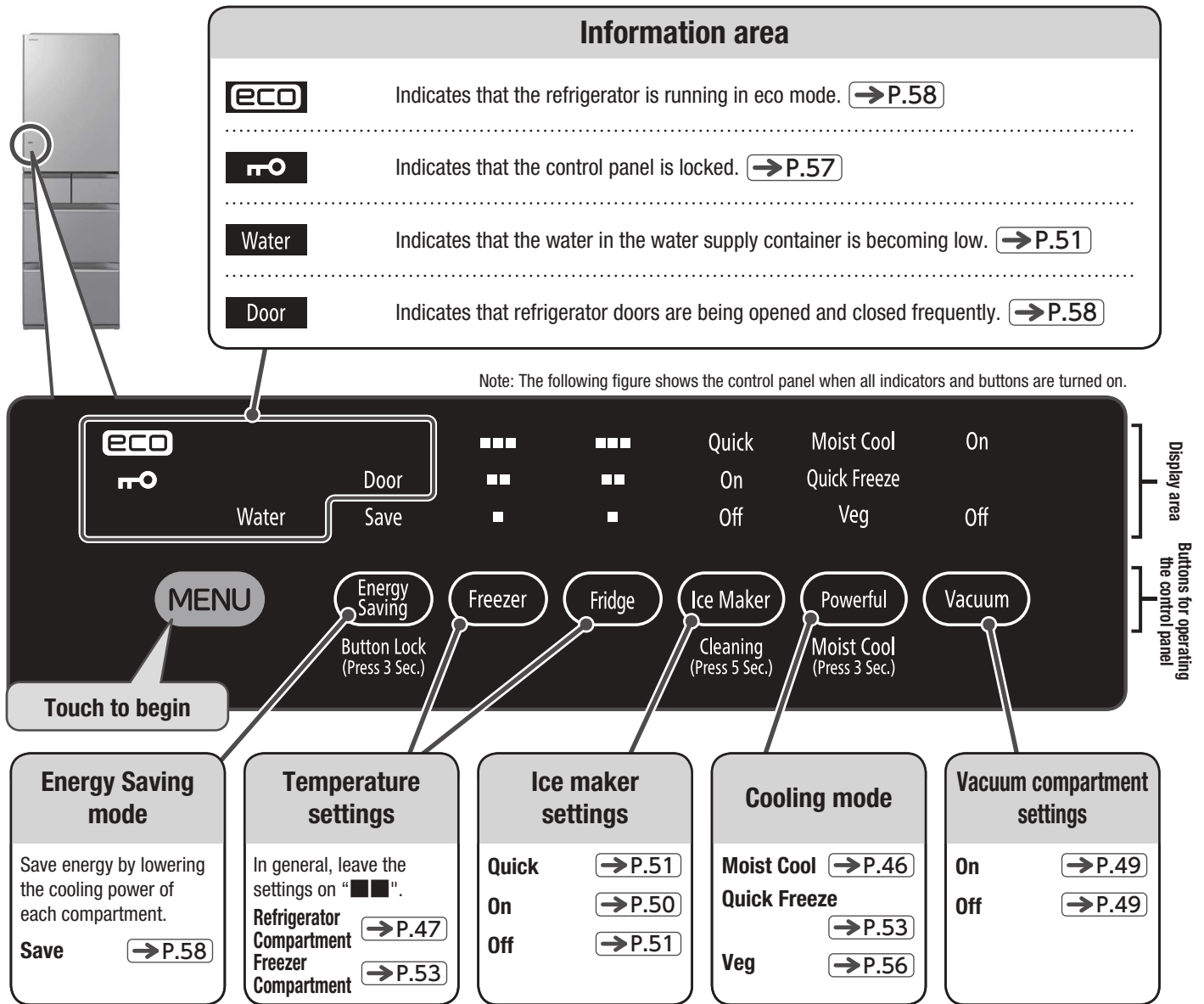

NOTES

- Touch **MENU** to display the control panel and view the current settings. You can also view the current settings when you open a door of the refrigerator compartment.
- After you finish configuring settings, touch **MENU** again to turn off the display of the control panel. Even if you do not touch **MENU** to turn off the display, the display will automatically turn off after 40 seconds. Note that, even when the display of the control panel is off, the following indicators will remain on: the "Save" indicator for energy-saving mode, the "Quick" and "Off" indicators for the ice maker, the "Off" indicator for the vacuum compartment, and the "eco", "Water", "Quick Freeze", and "Door" indicators in the information area.
- The display area and buttons for operating the control panel turn on when you open a door of the refrigerator compartment, and turn off approximately 15 seconds after all doors are closed.
- The response of the touch panel varies depending on the ambient temperature and humidity. Response can also be affected by electric appliances running in the vicinity of the refrigerator and by the user's physical condition.
- If the control panel does not respond when you touch it, stop touching the panel for a while, and then try again. Note that, if you touch a button multiple times in quick succession, the control panel might register the multiple button touches as a single, extended button touch. In addition, forcefully pressing a button will not improve the response of the control panel.
- The control panel might not respond if it is wet or dirty. If the control panel is dirty, clean it with a damp sponge or dishcloth, and then use a dry dishcloth to wipe away any excess water.
- The buttons for operating the control panel cannot be used while doors of the refrigerator compartment are open or while the indicators in the display area are blinking.

REFRIGERATOR COMPARTMENT

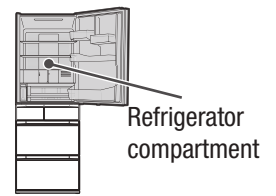

Parts

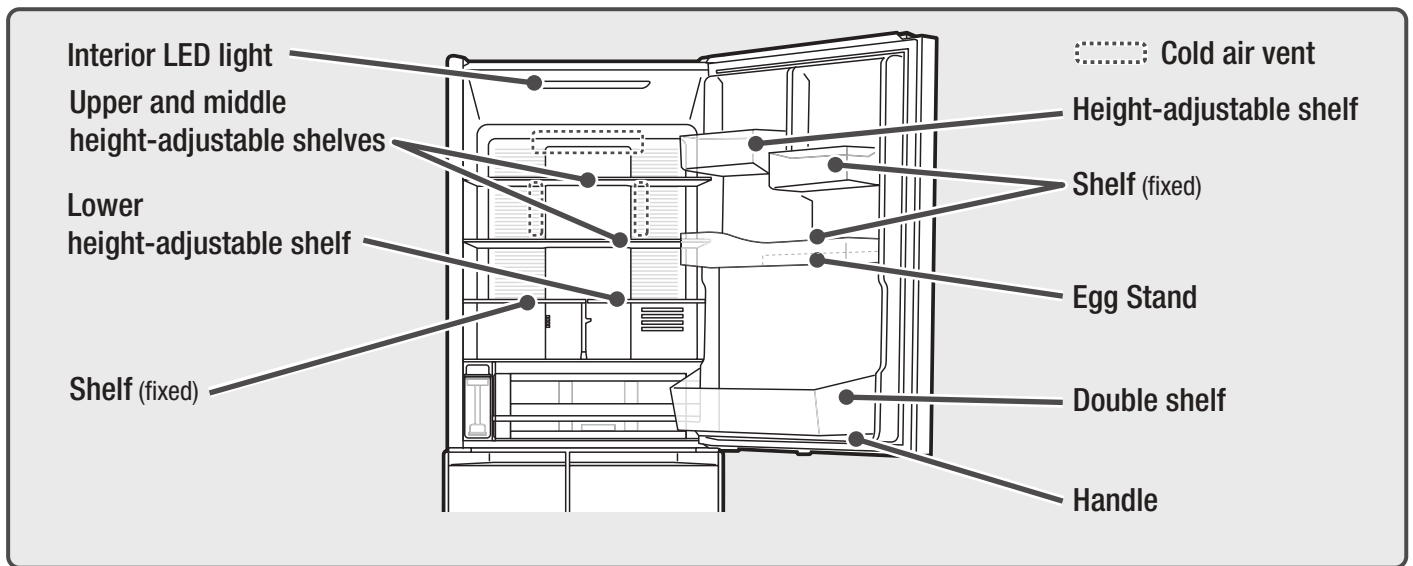

REQUEST

- Do not place foods with high water content or canned drinks directly in front of the cold air vent, as they might freeze or rupture, especially if the temperature setting is set to "■■■■" or the cooling mode is set to "Moisture Cooling". You can help prevent foods from freezing by covering them with lids or plastic wrap.
- When storing rice, seaweed, and other dried foods, be sure to store them in well-sealed containers or bags before putting them in the refrigerator. If such foods are not sealed tightly, they might take in moisture.

Preserving foods at lower temperatures (Using the Moisture Cooling function)

- Set lower temperatures (between 0°C to 3°C) for all refrigerator compartments.
The Moisture Cooling function is useful for preserving side dishes and other foods to be stored for an extended time. It also allows you to store food that is still warm (such as hot pot dishes) without worrying about the impact on other foods. When storing food that is still warm, **ensure it has cooled down to a temperature where it can be touched comfortably (50°C or lower)** before putting it in the refrigerator. (This is to prevent the risk of burns and of the deformation of the refrigerator shelves.)
- Whether it is set to "Moisture Cooling" can be checked on the operation panel.
While "Moist Cool" is lit, "Moisture Cooling" is set.

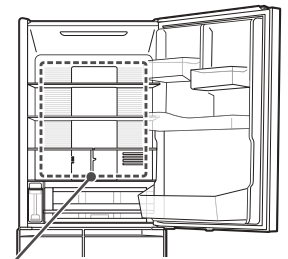

"Moisture Cooling" Area

NOTES

- When "Moisture Cooling" is set, more power is consumed than "■■■". Also, the operating noise may be loud.
- When "Moisture Cooling" is set, the pocket temperature is lower than "■■■".

How to set.

Set it "OFF" at purchasing.

1 Touch **MENU** button on the Control Panel to turn on the indicator lamp.

All indicator lamps turn on, and then the current settings are displayed.

2 Press and hold the button for 3 seconds or longer until the **Powerful** setting tone sounds (beep) so that the "Moist Cool" lamp turns on.

Fridge temperature setting Turns off.

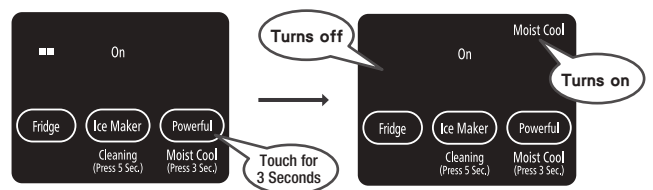

Cancel

Press the **MENU** button on the operation panel to light the indicator, and then press and hold it for 3 seconds or longer until the strong setting tone sounds (beep) so that the "Moist Cool" lamp turns off.

Adjusting the temperature of the refrigerator compartment

In general, leave the setting on “■■■”.

In summer or during other warm periods, if the refrigerator is not sufficiently cold, change the temperature setting to “■■■■”.

1 Touch **MENU** on the control panel to activate the control panel.

All indicators turn on, and then some will turn off to reflect the current settings.

2 Touch **Fridge** to change the temperature setting.



Temperature guide for the refrigerator compartment
 “■■■■” is about 1°C to 3°C lower than “■■■”.
 “■■” is about 1°C to 3°C higher than “■■■”.

REQUEST

During winter or other cold periods, if you set the temperature of the refrigerator compartment to “■■■■” for an extended period of time, some foods might freeze. If the refrigerator becomes too cold, change the setting to “■■■” or “■■”.

NOTES

- The temperature inside each compartment might fluctuate depending on how it is used.
- You can adjust the temperature in more detail. (→ P.56)
- Setting “■■■■” uses more electricity than setting “■■■”.
- Changing the temperature of the refrigerator compartment changes that of the vacuum compartment as well.
- Note that you cannot change the temperature of the refrigerator compartment when the Moisture Cooling function is on.

Adjusting the height of shelves

You can adjust the positions of shelves to fit the food and drinks you want to store. For information on how to attach or remove each part, see (→ P.62).



Warning

■ Handling glass shelves

- Do not strike or apply excessive force to the glass shelves. (The glass shelves might crack or shatter, causing injury.)
- The glass shelves are heavy. Take care when inserting and removing them.

■ Height-adjustable door shelves and the upper and middle height-adjustable shelves

You can adjust the position of them depending on the height of foods or beverage.

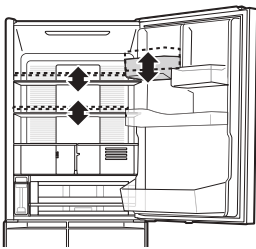

■ Lower height-adjustable shelf

You can adjust the shelf to the following heights:

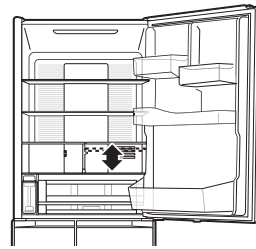

- Height at the time of purchase



- For storing pots, etc.

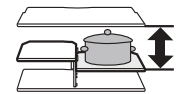

Set the shelf to the middle level

- For storing milk cartons, etc.

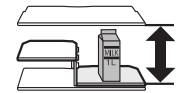

Set the shelf to the lowest level

VACUUM COMPARTMENT

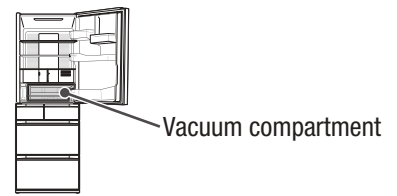

LED light
Lights up the vacuum compartment when the refrigerator doors are open.

Vacuum pump

Vacuum compartment (with aluminum tray)

Handle



Platinum catalyst Helps keep food fresh by breaking down odor particles released by meat and fish, and converting the particles into carbon dioxide.

Handle

Vacuum release valve (blue)
Lift the handle to unlock the valve and release the vacuum. You might hear a hissing sound as air enters the compartment.

Stored foods

At the time of purchase, the refrigerator is set to the "On" .

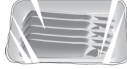
<p>"On" (About -2°C to 0°C)</p>	<ul style="list-style-type: none"> <li style="text-align: center;">● Meat, processed meat  <li style="text-align: center;">● Fish, seafood, boiled fish paste  <li style="text-align: center;">● Thawing meat or fish  <p>• Foods containing a lot of water may be frozen.</p>
<p>"Off" (About -2°C to 0°C)</p>	<p>The vacuum function is disabled. This setting is recommended to store food in "sealed bags" or "sealed plastic containers" , which requires caution in storing. Foods with a high water content may freeze because this is an ice-temperature compartment.</p>

NOTE

- The vacuum effect will not be changed even if foods are wrapped. If you are concerned about the transfer of smell, be sure to wrap a food item in question.

CAUTION

- Foods high in water content may freeze if ambient temperature is low.
- The temperatures of the Vacuum Compartments also change if the temperature of Refrigerator/Freezer Compartment is set to "■■■■" or "■".
- **Do not put too much food or too many containers in the Vacuum Compartment.**
Doing so may make it difficult to pull out the Vacuum Case.

■ Foods not suitable for the Vacuum Compartment

Freezing is not preferable for the following foods, store in Refrigerator Compartment.

● Dairy products



Cheese etc.

● Precut vegetables and fruits



Cut vegetables / cut fruits

● Food which form air bubbles inside if frozen



Tofu, konnyaku, deep-fried tofu, shirataki, boiled egg, etc.

Changing the vacuum compartment setting

1 Touch **MENU** button on the Control Panel to turn on the indicator lamp.

All indicator lamps turn on, and then the current settings are displayed.

2 Touch **Vacuum** button to change the settings as you like.

The display switches in sequence as shown below every time the button is touched. The temperature is set to "On" at the time of purchase.

CAUTION

- The "Off" indicator lamp continues to be lit during the "Off" operation. The display will be turned off after about 40 seconds for energy saving, but the function that is set once will remain effective.

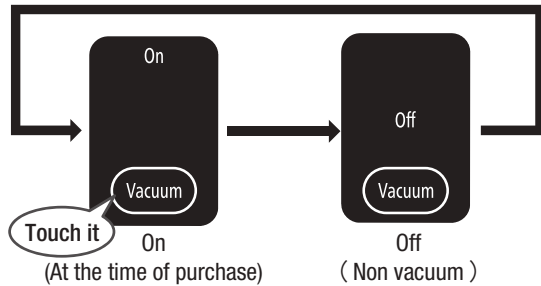

When opening/closing the door of the Vacuum Case

When opening the door

1 Pull up the handle to unlock.

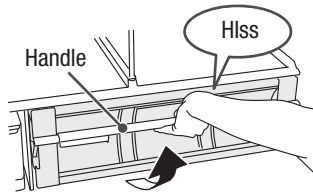

- It takes about three to four minutes for the Vacuum Case to be vacuumed after the vacuum pump starts to operate. The hissing sound may not be heard when the Vacuum Case is opened within four minutes.

2 Pull out the Vacuum Case.

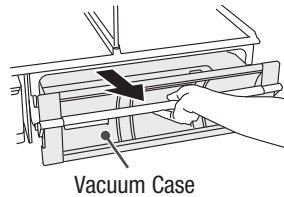

- The hissing sound indicates that vacuum is being released. Thus, the Vacuum Case cannot be drawn out while the sound is heard. Draw it out after the sound is no longer heard.

When closing the door

1 Push the Vacuum Case back to the end.

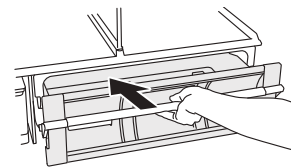

2 Press down the handle to lock.

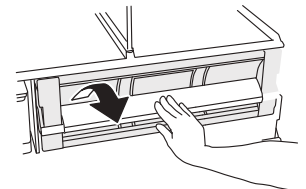

Caution

- The Vacuum Case is not put in the vacuum state unless the handle is pushed down securely.
- Closing the door of the Refrigerator Compartment without locking the handle may damage parts or food or form a clearance between the doors, which reduces cooling performance.

REQUESTS

- If a part of the gasket is stuck together, the vacuum state cannot be maintained. If it is stuck together, please remove it. Since it is difficult to see the left and right sides and the bottom, remove the Vacuum Chilled Case and check it. **→P.67**
- Dew and/or frost may be formed in the sealed Vacuum Compartment due to moisture contained in food or in the air. Soak a soft cloth in lukewarm water and wipe off the dew and/or frost with the cloth. (Attached dew, frost or ice does not reduce performance.)
- If you want to avoid dew, frost or ice, stored food should be wrapped with plastic wrap.
- Wipe water or soup spilled in the compartment soon, if any.
- The platinum catalyst needs no replacement. Do not remove it.

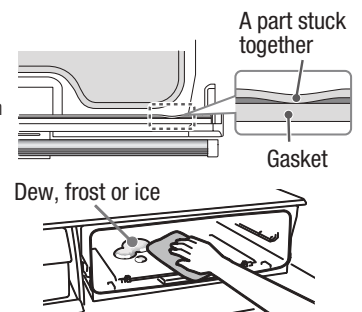

ICE COMPARTMENT (Automatic ice maker)

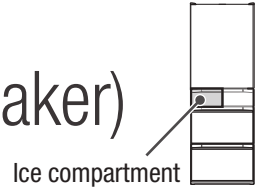

Water supply tank
(Holds about 1.0 liter)

Max fill line

Control panel

Display
Ice Making button
"Water Supply" indicator lamp

Ice container

Max fill line
Ice scoop
Store ice here
(Keep the ice scoop here when you are not using it.)

Ice compartment

Automatic ice maker

Automatic ice maker

Making ice

Clean the ice maker if you are using it for the first time or have not used for a week. → P.61

- 1 Touch **MENU** on the control panel to activate the control panel.**

All indicators will turn on, and then some will turn off to reflect the current settings.
- 2 Touch **Ice Maker** so that the "On" turns on.**

The ice maker is set to "On" at the time of purchase.

Turns on
On
Ice Maker
Cleaning (Press 5 Sec.)
Touch it
- 3 Pull the water supply tank out horizontally**

※The water supply tank may feel heavy when you lift and pull it toward you.

Handhold
- 4 Remove the lid and add water.**

Note: Do not fill the tank past the max fill line.

Lid
Max fill line
- 5 Put the water supply tank back in place.**

Push the tank all the way in, so that it is safely behind the tank-set line.

If the tank is not pushed all the way in, you will not be able to make ice.

Note: Tilting the water supply tank might cause water to spill out. If water spills out, wipe it clean as soon as possible.

Push all the way in
Tank-set line

REQUEST

- **WARNING:** Fill the water supply tank with potable water only.
- The quality of tap water might vary depending on your country or region. If you are concerned about the quality of your tap water, check with your local authorities.
- If you use any of the following types of water for the ice maker, wash the water supply tank frequently to prevent the accumulation of viscous liquid and the growth of bacteria: mineral water, well water, filtered water, or boiled water that has cooled down. → P.60
- If you use water high in mineral content to make ice cubes, when those ice cubes are put in liquid, they might release floating white particles (the mineral content). However, these particles are not harmful.
- If you use any of the following types of water for the ice maker, wash the water supply tank frequently (about once every three days) to prevent the growth of bacteria.

Mineral water
(Hardness: No more than 100 mg/L)

Filtered water or boiled water

Well water
(Must meet the applicable water quality standards)

- Do not use anything other than water for the ice maker. Using something other than water might damage the ice maker, cause deformities, or cause the resulting ice cubes to stick together.

Juice

Sports drinks

Soda

Tea

6 The ice maker starts automatically.

- The ice maker stops when ice cubes in the ice container reach the max fill line and automatically resumes when ice cubes begin to run out.
- If the ice container is empty, ice cubes landing in the container might produce a loud sound.

Amount of ice that can be stored and time required to make ice

Model		R-HWS480K type
Storable amount	When ice cubes are level	About 140 ice cubes
Time required to make 12 ice cubes	Set to "On"	About 110 minutes to 140 minutes
	Set to "Quick"	About 80 minutes

Note: The above estimates assume the following: the ambient temperature is 30°C, the temperature setting for both the refrigerator and freezer compartments is set to "■■■", and the refrigerator doors are closed throughout the duration of ice making.

NOTES

- If ice cubes accumulate in one area of the ice container, the ice maker might stop even if there are not many ice cubes.

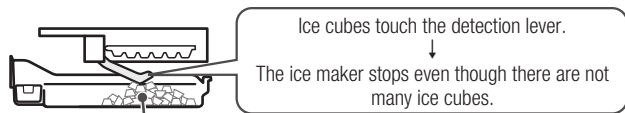

The ice cubes accumulate in one area of the container.

- In the following situations, it might take some time to make ice.
 - If you are using the ice maker for the first time (It might take 24 hours or more.)
 - If the temperature setting of the freezer is set to "■"
 - If the freezer is full
 - If "Energy Saving" mode is on

- If you level the ice cubes, you can prevent the ice maker from stopping prematurely and thus create more ice.

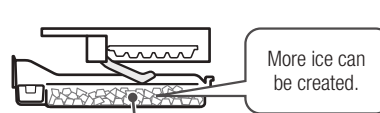

The ice cubes are level.

- If the refrigerator doors are frequently opened and closed
- If the doors to the freezer or ice compartment are left open
- If the ambient temperature is low (for example, in winter)
- If there is a power outage

REQUESTS

- While the ice maker is set to "Quick" or "On", do not put anything (frozen foods, the ice scoop, etc.) other than ice made by the ice maker in the ice container. Putting food or other items in the ice container can lead to the following problems: you might not be able to make ice, or part of the ice maker might get caught on the food or other item, causing the part to break or preventing the door to the ice compartment from opening.
- Open and close the door to the ice compartment with care. If you open or close the door forcefully, ice might fall from the ice container into the freezer compartment.

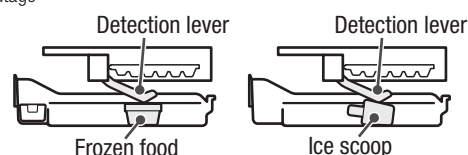

Do not put frozen foods in the ice container. Do not put the ice scoop in the ice container.

Making ice quickly

- 1 Touch **MENU** on the control panel to activate the control panel.

All indicators will turn on, and then some will turn off to reflect the current settings.

- 2 Touch **Ice Maker** so that the "Quick" indicator turns on.

NOTES

- While "Quick" is operating, the "Quick" display continues to light. Also, the "eco operation indicator lamp" does not light up.
- While "Quick" is operating, cooling for the freezer compartment is given priority, so the temperature of the refrigerator compartment is likely to increase when the doors are opened and closed frequently.

Turning the ice maker off

- 1 Touch **MENU** on the control panel to activate the control panel.

All indicators will turn on, and then some will turn off to reflect the current settings.

- 2 Touch **Ice Maker** so that the "Off" indicator turns on.

Note: If the ice maker setting is set to "Off" for more than a week, clean the ice maker. → P.61

Water supply indicator

The "Water" indicator turns on when water in the water supply tank is getting low. Refill the tank.

If you open and close the left-side refrigerator door while this indicator is on, the indicator will turn off. If the refrigerator detects that the tank has not been refilled, the indicator will turn on again (within 3 hours).

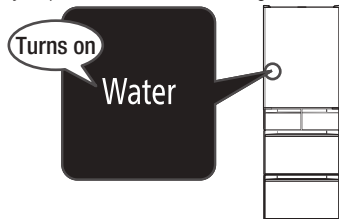

NOTES

- If the ice maker setting is set to "Off", the "Water" indicator will remain off.
- Even if there is water in the water supply tank, if the tank is not pushed all the way in, the "Water" indicator will remain on. Ensure the water supply tank is pushed all the way in.
- Even if the ice maker setting is set to "On", if the ice container is full, the "Water" indicator might not turn on.

When the "On" indicator blinks, or the "■■■" and "■" freezer indicators and the "■" fridge indicator blink

If the ice maker's "On" indicator blinks, the ice tray might have come into contact with food inside the ice container.

Empty the ice container, and then clean the ice maker. → P.61

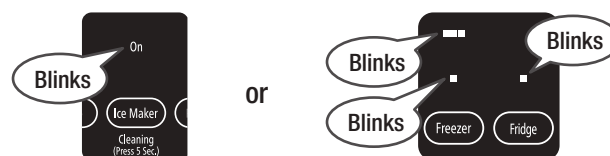

or

FREEZER COMPARTMENTS

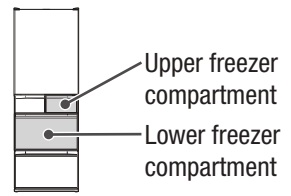

Upper freezer compartment

Useful for storing foods used on a daily basis and foods that are partially used.

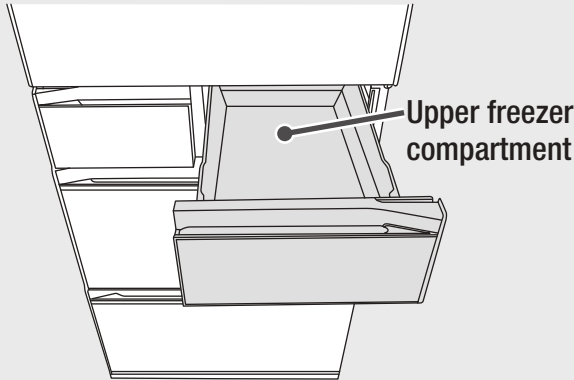

Lower freezer compartment

Provides a lot of storage, organized into three easy-to-reach containers. Useful for long-term storage, and for storing ice cream and other foods that melt easily.

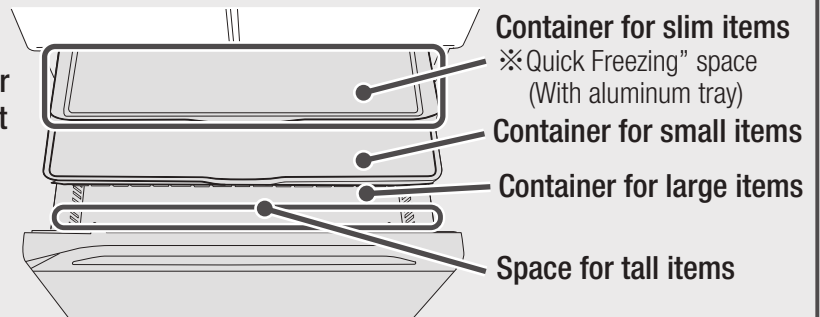

CAUTION ● Do not remove the container for slim items.

Type of foods that can be stored

Upper freezer compartment		Items stored in sealable bags or airtight containers, sliced bread, etc.
Lower freezer compartment	Container for slim items	Small-sized frozen foods, etc. “Quick Freezing” space Meat, fish, or rice to be frozen in a short amount of time.
	Container for small items	Items stored in sealable bags or airtight containers, etc.
	Container for large items	Frozen foods, ice cream, etc. Space for tall items Frozen bottled drinks.

Notes on using the freezer compartments

Store items in the appropriate space based on their size. As a general rule, do not put items in a container if the item is taller than the height of the container. Ensure that items in one container do not touch the partition (or any other container) above that container.

Incorrect storage of items might damage the containers or the items themselves. Alternatively, you might not be able to close the freezer doors all the way, resulting in reduced cooling performance.

CAUTION

- Do not store 500-milliliter bottled drinks in the container for slim items. When the drink freezes, the bottle will expand and you might not be able to remove it.
- Do not use the freezer compartments with the container for slim items or the container for small items removed. Items might fall behind certain containers and, as a result, you might not be able to close the doors all the way.
- Store only foods that can be frozen. For example, when storing bottled drinks, ensure that the bottle can withstand freezing.

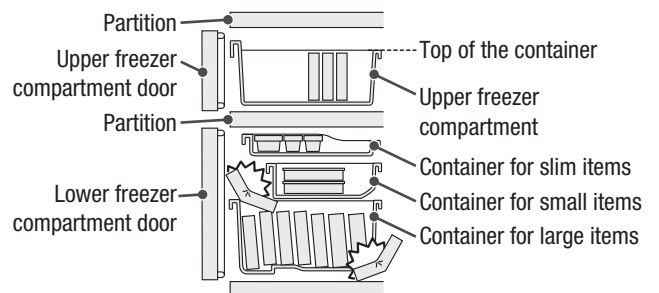

Adjusting the temperature of the freezer compartments

At the time of purchase, the temperature setting of each compartment is set to “■■■”. In general, leave the setting on “■■■”. In summer or during other warm periods, if the refrigerator is not sufficiently cold, change the temperature setting to “■■■■”.

1 Touch **MENU** on the control panel to activate the control panel.

All indicators turn on, and then some will turn off to reflect the current settings.

2 Touch **Freezer** to change the temperature setting.



Temperature guide for the refrigerator compartment
 “■■■■” is about 2°C to 4°C lower than “■■■”.
 “■■■” is about 2°C to 4°C higher than “■■■”.

REQUEST

- If the freezer becomes too cold, change the setting to “■■■” or “■■”.

NOTES

- The temperature inside each compartment might fluctuate depending on how it is used.
- You can adjust the temperature in more detail. (→ P.56)
- Setting “■■■■” uses more electricity than setting “■■■”.
- Changing the temperature of the freezer compartments changes that of the ice compartment as well.

Quickly freezing foods (Quick Freezing)

The effects of aluminum trays allows foods to be frozen more quickly.

Wrap food in plastic film or put it in a freezer bag and then place it on the aluminum tray. Dividing food into small and thin pieces makes it not only easier to freeze the food right through to the middle, but also easier to take out.

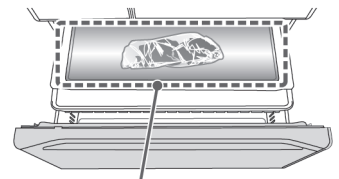

Quick Freezing Corner

NOTES

- Food can be frozen more efficiently if placed in close contact with the aluminum tray and not stacked.

How to set.

This function is turned off at the time of purchase.

1 Touch **MENU** on the control panel to activate the control panel.

All indicators will turn on, and then some will turn off to reflect the current settings.

2 Touch **Powerful** button to turn on the “Quick Freeze” indicator lamp.

During “Quick Freeze” mode, “Quick Freeze” indicator lamp is kept ON. [“eco” Operation indicator lamp] is turned off.

The operation will end automatically in about 90 minutes, and “Quick Freeze” indicator lamp will be turned off.

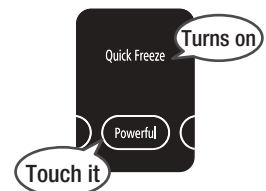

To cancel it Touch **MENU** button on the Control Panel to turn on the indicator lamp, and touch

Powerful button to turn off “Quick Freeze” indicator lamp.

NOTE

- Freezer compartment is cooled preferentially in the “Quick Freeze” operation. For that reason, temperature of the Refrigerator Compartment may rise if the Refrigerator Compartment door is opened/closed frequently.
- Touching **Powerful** button again within 60 minutes after the end of the “Quick Freeze” operation, the lamp is illuminated, but the “Quick Freeze” operation does not start. The operation will start after 60 minutes pass.
- Ensure to wrap the food with plastic film to prevent it from sticking on the aluminium tray.
- More power is consumed during the “Quick Freeze” operation than during the normal operation.

VEGETABLE COMPARTMENT

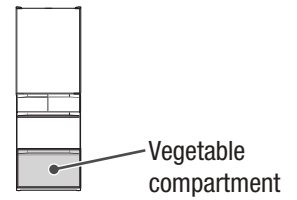

Platinum catalyst case Odor particles and ethylene gas emitted by vegetables are converted into carbon dioxide, helping vegetables stay fresh longer.

Upper container

Lower container
 ※When removing it, remove the partition first. The partition may fall.

Partition

Moisture-retention unit
 (Do not remove it.)

Space for tall items

Upper container

Door of the vegetable compartment

Partition

Lower container (Aero-care Zone)

Type of foods that can be stored

Upper container	Partially used vegetables, small vegetables, fruit, etc.
Lower container	Leafy vegetables (spinach, etc.) and bulky vegetables (cabbage, lettuce, etc.) 
Space for tall items	Tall vegetables, 2-liter bottled drinks

Notes on using the vegetable compartment

Store items in the appropriate space based on their size and type.

- **Ensure that food does not protrude from the container.**
 - Items protruding out from the top of a container might damage containers or the items themselves.
 - Alternatively, you might not be able to close the door of the vegetable compartment all the way, resulting in reduced cooling performance.
 - Some types of food and some bottles might not fit in this compartment.
- **Do not use the vegetable compartment with the upper container removed.**
 - Items might fall behind lower container and, as a result, you might not be able to close the door all the way.
- **Do not forcibly pack foods or drinks into the vegetable compartment.**
 - It may damage the partition or box.

Guide to storing items based on their height

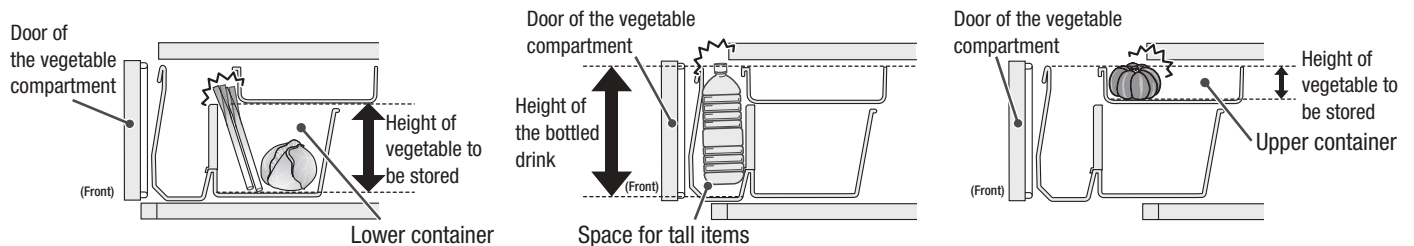

Tips for storing vegetables

Types of food recommended to be kept at room temperature

- We recommend that the following types of food be kept in a cool location away from direct sunlight: garlic, onion, potatoes, sweet potatoes, squash, and whole (uncut) pumpkins.



Risk of damage due to low temperatures

Some foods might change color or lose flavor if stored in the vegetable compartment for an extended period of time. Other types of food might lose their vitamin C content, grow mold, or spoil.

Types of food easily damaged when stored in low temperatures

- Vegetables: Tomatoes, green pepper, cucumber, eggplants, green beans, sweet potatoes, okra, etc.

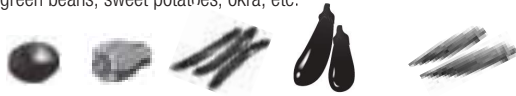

- Fruits: Bananas, pineapple, mangos, papayas, avocados, lemons, etc.



NOTES

- The temperature of the space for tall items is slightly higher than that of other containers.

When this happens

- If the vegetable compartment contains only a few items, it might not be able to maintain a high level of moisture. In such cases, wrap the items to be stored, in plastic wrap to prevent them from drying out.
- The moisture level of the vegetable compartment is relatively high. As such, depending on the amount and types of vegetables stored in the compartment, moisture might condense on the surfaces of containers or on items stored in the compartment. If you are concerned about moisture condensing on the surface of foods, wrap foods in plastic wrap before storing them in this compartment.
- If the moisture-retention unit is blocked (for example, by food in containers or bags), moisture is more likely to condense. Be sure to store food in a way that does not block the moisture-retention unit.
- Water accumulating in the container might cause food to spoil faster. Use a sponge or dishcloth to wipe up any water that accumulates.
- Dried food (rice, laver, etc.) stored in the vegetable compartment might absorb moisture. To prevent this, put the dried food in a sealed container or bag before storing it in the vegetable compartment.

VARIOUS FUNCTIONS

Detailed temperature adjustment (refrigerator and freezer compartments)

You can adjust the temperature settings for the refrigerator and freezer compartments in more detail by selecting from a total of 11 settings.

- 1** Open the door of the lower freezer compartment.
 - 2** Touch **MENU** on the control panel to activate the control panel.
All indicators will turn on, and then some will turn off to reflect the current settings.
 - 3** Touch **Fridge** for 5 seconds or more until you hear a beep.
 - 4** Close the door of the lower freezer compartment.
 - 5** Adjust the temperature settings by using **Fridge** **Freezer**.
Each time you touch a button, the corresponding indicators will change in the order shown below. We recommend that you set "■■■".
(Lighting Blinking Turned off)
- | Indication lamp | ■ | ■ | ■ ■ | ■ ■ | ■ ■ | ■ ■ | ■ ■ ■ | ■ ■ ■ | ■ ■ ■ | ■ ■ ■ | ■ ■ ■ |
|-----------------|---------------|------|-----|-----|-----|------|-------|-------|-------|-------|--------------|
| Setting | MIN and under | MIN. | → | → | → | MID. | → | → | → | MAX. | MAX and more |
- Cancel** Perform steps 1 to 4 above.
The refrigerator will beep twice to indicate that detailed temperature adjustment has been canceled. You can then set the temperature by selecting from the 3 regular levels.

Adjusting the temperature of the vegetable compartment (setting the cooling mode to Veg)

- 1** Touch **MENU** on the control panel to activate the control panel.
All indicators will turn on, and then some will turn off to reflect the current settings.
 - 2** Touch **Powerful** so that the "Veg" indicator turns on.
The temperature of the vegetable compartment when "Veg" mode is on (about 2°C to 6°C) is lower than when "Veg" mode is off (4°C to 8°C).
Note: The above estimates assume the following.
 1. The ambient temperature is 32°C.
 2. The temperature setting for both the refrigerator and freezer compartments is set to "■■■".
 3. Nothing is stored in the refrigerator.
 4. The doors of the refrigerator are closed and the temperatures of each compartment allowed to stabilize.

NOTE
To save energy, the indicator will automatically turn off after 40 seconds. However, the setting will remain set until you change it.
When "Veg" mode is on, the "eco" indicator is turned off.

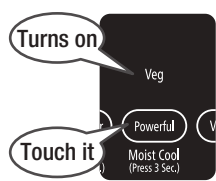
- Cancel** Touch **MENU** on the control panel to activate the control panel.
Turn **Powerful** so that the "Veg" indicator turns off.

NOTES

- Vegetables with high water content might freeze if stored for an extended period of time in the vegetable compartment with "Veg" mode on.
- If you set "Energy Saving" mode while "Veg" mode is on, the cooling mode will change from "Veg" to a weaker cooling mode. → P.58

REQUEST

In the following cases, turn "Veg" mode off.

- If you are worried about soft spots forming on or the discoloration of eggplant and other vegetables that are easily damaged by low temperatures.
- If you are worried about moisture condensing in the vegetable compartment.

Door alarm

If a refrigerator door* is left open for more than 1 minute, the refrigerator will emit a warning sound.

* The alarm works for doors of the refrigerator compartment, ice compartment, and lower freezer compartment. It does not work for the doors of the upper freezer compartment or vegetable compartment.

Duration when door is open	1 minute	2 minutes	From 3 minutes onward
Alarm sound	Long beep (3 beeps)	Long beep (5 beeps)	Long beep (continuously), Louder
Display area	Blinking	Blinking	Blinking
For operation	Light ON	Light ON	Light ON

NOTES

- While the indicator lamp is blinking on the display area, the Control Panel remains inactive upon touching. Close the door before starting operation.
- Door alarm rings after 30 seconds when the door has been opened only in case the power “Energy Saving” mode set. However the indicator blinks after 1 minute of the opening.

Adjusting the volume of the door alarm and control panel

You can adjust the volume of the door alarm and control panel, or mute all sounds.

Standard volume levels are set at the time of purchase.

1 Touch **MENU** on the control panel to activate the control panel.

All indicators will turn on, and then some will turn off to reflect the current settings.

2 Touch the **Fridge** button for 3 seconds or more until you hear the preset sound.

Each time you touch the button for 3 seconds, the volume of control panel sounds will change from standard, to loud, and then to off. Repeat this step until you reach the desired volume level. (For details, see the following table.)

Volume level	Standard	Loud	Off	Standard
Preset sound	–	→ 2 long beeps	→ Long beep	→ 2 short beeps

(At the time of purchase)

NOTES

- You cannot set separate volume levels for the door alarm and the control panel.
- If the door alarm is turned off, indicators on the control panel will not blink.
- Even if the door alarm is turned off, the alarm for the ice-maker cleaning function will still work. (→ P.61)
- If you unplug the power cord or a power outage occurs, when power is restored, the door alarm and control panel sounds will be reset to the standard volume level.

Locking the control panel

Locking the control panel prevents the refrigerator settings from being inadvertently changed.

When the **LOCK** indicator is on, other buttons of the control panel will not activate even if they are touched.

1 Touch **MENU** on the control panel to activate the control panel.

All indicators will turn on, and then some will turn off to reflect the current settings.

2 Touch the **Energy Saving** button for 3 seconds or more until you hear the preset sound.

This locks or unlocks the control panel.

At the time of purchase, the control panel is not locked. (The **LOCK** indicator is turned off.)

Control panel	Locked	Unlocked
LOCK indicator	On LOCK	Off
Preset sound	Long beep	2 beeps

NOTES

- If you unplug the power cord or a power outage occurs, when power is restored, the control panel might be unlocked.
- To save energy, the **LOCK** indicator will automatically turn off after 40 seconds. However, the control panel will remain locked until you unlock it.

Triple-power deodorizing function (refrigerator compartment)

Three types of deodorizers help eliminate various odors, including those caused by sulfur, nitrogen, aldehyde, and acid.

SAVING ENERGY

Using “Energy Saving” mode

To save energy, use “Energy Saving” mode, which lowers the cooling power of each compartment.

If “Energy Saving mode is on, and the doors of the refrigerator compartment are left open for more than 30 seconds, the door alarm will sound, and the interior LED lights of the refrigerator compartment and vacuum compartment will dim to save energy. If the refrigerator doors are closed for an extended period of time, the interior of the refrigerator will cool gradually, helping to save even more energy.

1 Touch **MENU** on the control panel to activate the control panel.
All indicators will turn on, and then some will turn off to reflect the current settings.

2 Touch the **Energy Saving** button so that the “Save” indicator turns on.
“Energy Saving” mode is off at the time of purchase.

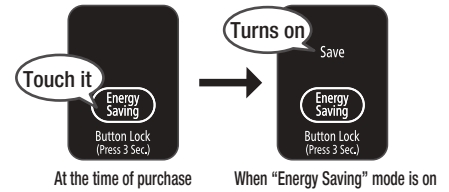

Cancel Touch **MENU** button on the Control Panel to turn on the indicator lamp, and touch **Energy Saving** button to turn off “Save” indicator lamp.

NOTES

- As the cooling power is reduced when “Energy Saving” mode is on, ice cream and other frozen foods might become soft. In addition, it might take more time to freeze foods or to make ice.
- The “Save” indicator lamp is turned on during the “Energy Saving” mode.
- If you set “Ice Maker” to “Quick”, “Quick Freeze” while “Energy Saving” mode is on, the cooling power will temporarily return to normal strength.
- If “Energy Saving” mode is on and the cooling mode is set to “Veg”, the cooling power will be even lower than when only “Veg” is set. → P.56
- If the temperature setting of any of the refrigerator or freezer compartments is set to “■”, the cooling power of those compartments will not be further reduced

“eco” indicator

When the refrigerator is running relatively stably, the **eco** indicator turns on, indicating that the refrigerator is running in eco mode.

Use this indicator as a guide to saving energy. As a general rule, minimize how frequently you open and close the refrigerator doors and how long doors remain open.

NOTES

If the **eco** indicator is off, the following causes are possible.

- A large volume of food was stored in the refrigerator all at once, or immediately after installation.
- Refrigerator doors were opened and closed frequently. (When the “Door open / close sign” is lighting.)
- An item (food, bag, etc.) is caught in a door, preventing the door from closing completely.
- The ice maker setting is set to “Quick”, “Quick Freeze”, or the cooling mode is set to “Veg”.
- The ambient temperature is about 35°C.

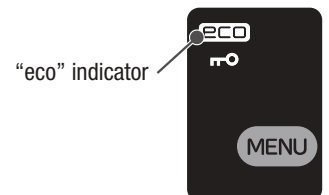

“Door” indicator

The **Door** indicator automatically turns on when it detects refrigerator doors being frequently opened and closed. To save energy, minimize how frequently you open and close the refrigerator doors.

NOTES

- The **Door** indicator automatically turns off after about 5 minutes.
- The **eco** indicator remains off while the “Door” indicator is on.

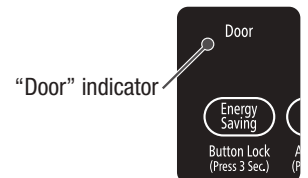

MAINTENANCE



WARNING

Unplug the refrigerator before performing maintenance.

■ Cleaning the refrigerator

Keep the refrigerator clean by wiping away dust, spilled foods, and other residue as soon as you notice them. In addition, we recommend that you perform a detailed cleaning of all parts (including those not visually accessible) at least once a year.

Power plug

Once or twice a year

Unplug the power plug, and then wipe it clean with a dry dishcloth.

For details on preventing fires and electric shock: → P.38-41



Door gaskets

Once a month

Wet a sponge or dishcloth in warm water, and wipe off the door gaskets.

Clean the gaskets thoroughly, as they can become dirty easily.

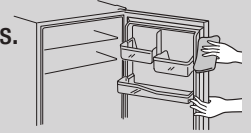

Door surfaces

Once a month

Wet a sponge or dishcloth in warm water. Wipe down the surfaces and then dry them by using a dry dishcloth.

If there is residue from adhesive tape on the glass surface, rub the residue with an eraser and then wipe off the residue by using a dry dishcloth.

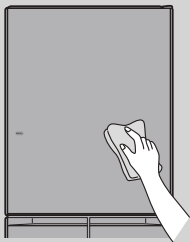

Shelves

Once every three months

Wet a sponge or dishcloth in warm water, and wipe off each shelf.

For details on how to remove shelves: → P.62

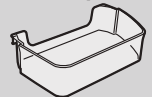

Drip pan

Once a month

Wet a sponge or dishcloth in warm water, and clean the drip pan.

If the liquid has accumulated in the drip pan or the pan is dirty, wipe the pan clean.

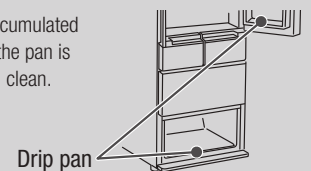

Back and bottom surface of the refrigerator

Remove the leg covers. Lift the adjustable mounts off the floor and pull the refrigerator toward you. Then, clean the back and bottom surface of the refrigerator.

Once or twice a year

- Due to the convection of air, the back of the refrigerator attracts dust and dirt. If the floor is easily scratched, put a board or similar item under the refrigerator to protect the floor.
- If you are concerned about the loud vibration noise, condensation behind the refrigerator due to high humidity, or the discoloration or staining of the wall or wallpaper behind the refrigerator, leave at least 2 centimeters of space between the refrigerator and the back wall.

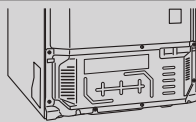

Containers and trays

Once every three months

Wet a sponge or dishcloth in warm water, and wipe off each container and tray.

If you wash the lower container of the vegetable compartment, turn the container over to let excess water run out. Then, dry the container thoroughly. Do not use a toothbrush, scrubbing brush, or other instrument with long bristles to clean the containers or trays, as such instruments might scratch or otherwise damage the containers, trays, or moisture-retention unit.

For details on how to remove containers and trays: → P.63

Note: Ensure the platinum catalyst does not get wet.

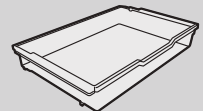

NOTES

- Do not use any of the following products when cleaning the refrigerator, as these products might scratch or discolor the refrigerator's doors, surface coating, and plastic and glass parts.



Alkaline or weak-alkaline kitchen cleaning agents (any non-neutral cleaning agent), glass cleaners, chlorine bleach

Scrubbing brushes, polishing sponges, chemical sponges (dry cleaning sponges)

Polishing powder, powdered soap

Benzene, paint thinner, alcohol

Hot water

Be sure to check the labels of cleaning agents and ensure they are safe for use on refrigerators.

- If cooking oil, soup, or some other liquid gets on any part of the refrigerator, wipe it off immediately to prevent damage or discoloration of the refrigerator part.
- Do not wipe off the lubricant on the slide rails of containers/drawers or on the surfaces in contact with the slide rails. (This lubricant conforms to Japan's food hygiene law.)
- If you attach magnets or suction cups to the refrigerator doors or other parts, the magnets or suction cups might leave a mark on the surface of the refrigerator.
- If you unplug the power cord, some control panel settings might be reset. After plugging in the power cord, check the settings.

MAINTENANCE (continued)

Vacuum compartment Once a month

1 Remove the vacuum compartment.

For details on how to remove the vacuum compartment: → P.62

Be sure to remove any items stored in the vacuum compartment.

2 Wet a sponge or dishcloth in warm water, and wipe the following parts.

Note: Do not use any detergents or other cleaning agents.

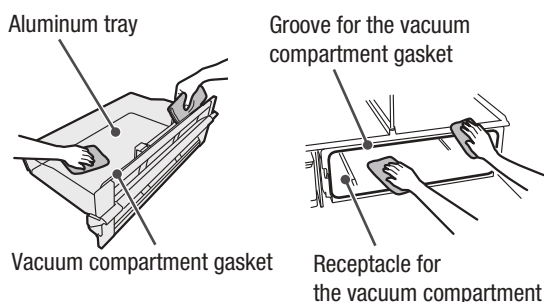

NOTES

- Gently wipe the ceiling of the vacuum compartment, especially in the vicinity of the interior LED light. Excessive force might damage the light.
- Using any cleaning agent other than warm water on the vacuum compartment gasket might damage, deform, or discolor the gasket and reduce the effectiveness of the vacuum.

3 Re-installing the vacuum compartment.

For details on how to install the vacuum compartment: → P.62

If the packing of the vacuum compartment door is loose or not close firmly, the vacuum cannot be maintained.

When the packing of the vacuum compartment door is too dirty.

1 Wash the gasket by using a soft sponge.

Note: Do not use any detergents or other cleaning agents.

2 Use a dry dishcloth to wipe off any excess water and then allow the gasket to dry naturally.

Water supply tank Once a week

1 Remove the water supply tank and its cover.

Open the tank by removing the cover in the directions indicated by the arrows.

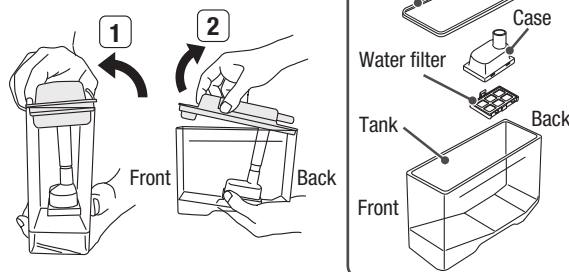

2 Remove the gasket and case from the cover.

Pull the case to remove it from the cover.

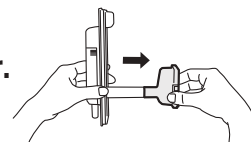

3 Remove the water filter from the case.

To remove the water filter, pull the tab of the water filter to separate it from the catch.

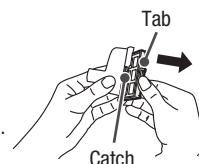

4 Wash each part of the water supply tank.

Wash each part by using a soft sponge. Do not use any detergents or other cleaning agents.

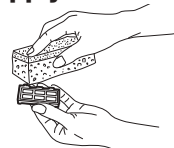

NOTE

- Replace the water filter every 3 to 4 years or as needed.

5 Reassemble the water supply tank, and then fill the tank.

Reattach the case to the cover by aligning the tubes and inserting the tube of the cover into that of the case.

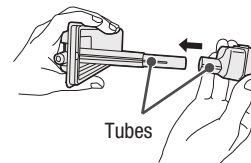

Close the tank by attaching the cover in the direction indicated by the arrow.

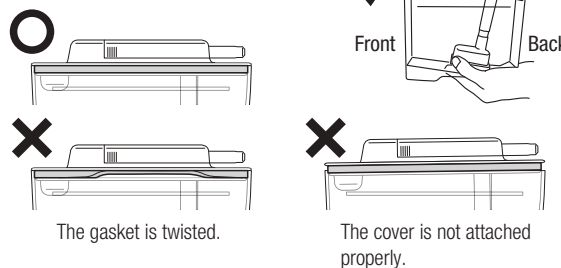

REQUEST

If you do not plan on using the automatic ice maker for a period of time, clean the water supply tank, wait for it to dry completely, and then re-install it in its place. (Ensure the water filter and all other parts of the tank are completely dry.)

Cleaning the ice maker

Before using the ice maker for the first time or if you have not used the ice maker in over a week.



WARNING

Do not touch the mechanical parts of the automatic ice maker.
(Touching these parts might result in injury.)

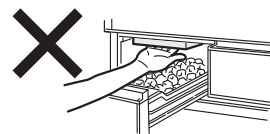

Wash the ice tray and other parts that come in contact with water.

Preparation

Check the following before cleaning the ice maker.

Water supply tank

- Fill the tank up to the max fill line.
- Set the tank correctly in place.

Ice container

- Remove any ice cubes remaining in the ice container.



After checking the above, close all doors of the refrigerator, and then proceed to step 1.

1 Touch **MENU** on the control panel to activate the control panel.

All indicators will turn on, and then some will turn off to reflect the current settings.

2 Touch the **Ice Maker** button for 5 seconds or more until you hear the alarm.

All three ice maker indicators ("Quick", "On", and "Off") will blink and then cleaning on the ice maker will start. (Cleaning takes about 4 minutes.)

- The indicators will blink and the alarm will sound continuously for about 4 minutes.
- Once cleaning starts, you cannot stop it before it finishes.
- Do not open any door of the refrigerator while the ice maker is being cleaned.
Opening a door in the middle of cleaning might cause problems.
- The alarm for the ice-maker cleaning function will sound even if the door alarm is disabled. → P.57

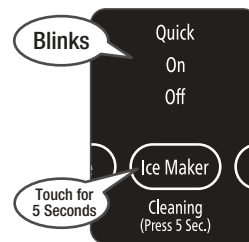

3 When the alarm stops, place a clean towel in the ice container to prevent water from spilling out.

There is a notch at the back of the ice container. To prevent the water that accumulated during cleaning from spilling out from this notch, place a clean, absorbent towel towards the back of the container.

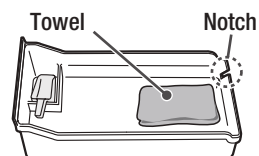

4 Remove and dry the ice container. Then put it back in the ice compartment.

Remove the towel that you placed in the ice container in the previous step.
Any water remaining in the water supply tank can be used to make ice.
After cleaning finishes, the ice maker will be set to "On".

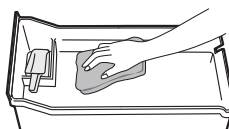

HOW TO REMOVE/INSTALL PARTS

CAUTION

- Before removing any part of the refrigerator, remove all items stored in or on the relevant part.
- Do not remove any refrigerator parts other than those listed in this section.
To remove or clean parts not listed in this section, contact a customer service center.
- Do not remove or wash the platinum catalysts in the vacuum compartment and vegetable compartment.

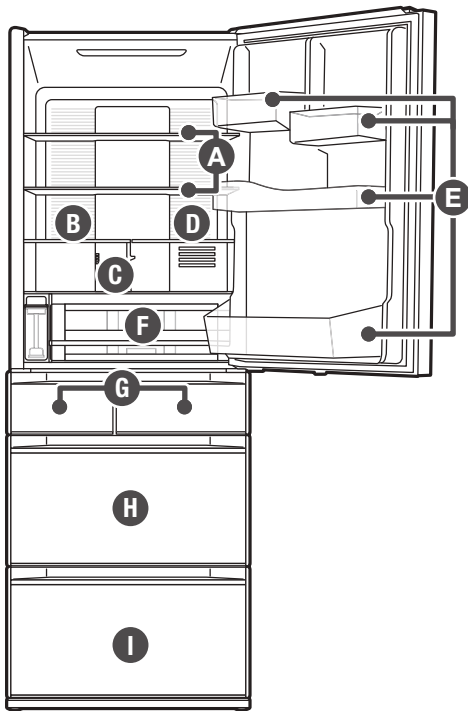

A Upper and middle height-adjustable shelves

NOTES

Remove the middle shelf before removing the upper shelf.

- 1 Slightly lift the back of the shelf and then pull the shelf forward.
- 2 Continue to pull the shelf forward as shown in the figure below.
- 3 Rotate the shelf to remove it.

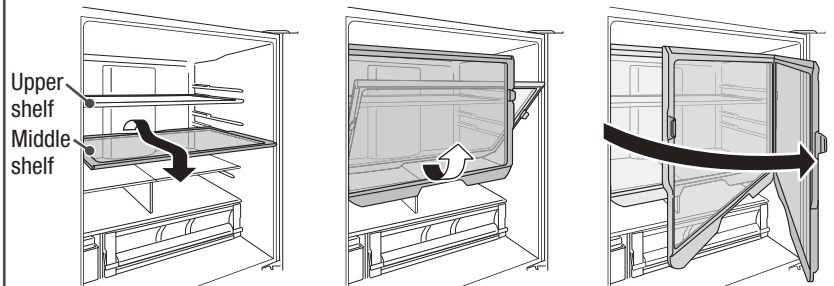

NOTE

The glass shelves are heavy. Take care when inserting and removing them. If you drop a shelf, it might crack or shatter, causing injury.

B Fixed shelf

Slightly lift the back of the shelf and then pull the shelf forward.

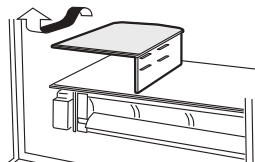

Remove the lower height-adjustable shelf before removing the fixed shelf.

C Shelf partition

- 1 Hold the back of the partition and then rotate the partition forward.
- 2 Remove the partition by pulling it toward the back of the refrigerator.



D Lower height-adjustable shelf

Lift the shelf to remove it.

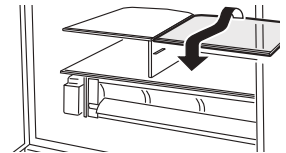

E Door shelves

Lift each door shelves to remove it. Each shelf is very securely attached, so you might need to lightly tap the bottom-left and right sides of the shelf to dislodge it.

CAUTION

When reattaching each shelf, ensure to attach it securely.
If a shelf is not securely attached, it might fall off, causing injury.

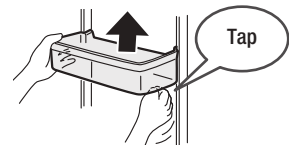

F Vacuum compartment

Removal

Pull out the vacuum compartment. Then, lift the front of the compartment and continue pulling the compartment out in an upward direction.

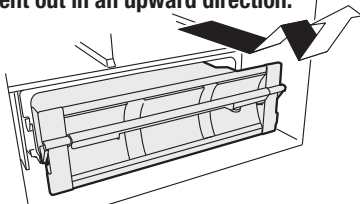

Installation

Align both the left and right protruding tabs of the vacuum compartment with the guide rails of the receptacle, and then insert the compartment. When the compartment is all the way in, press the handle down to lock the compartment.

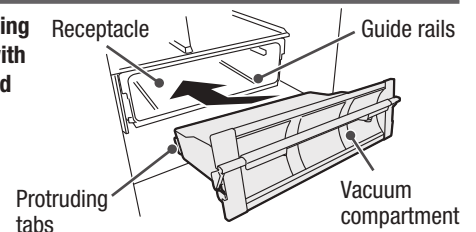

REQUEST

After installing the compartment, open and close the compartment a few times to ensure it has been installed correctly.

G Ice container (ice compartment) and upper freezer container (upper freezer compartment)

Open the door of the compartment and then lift the container.

When installing the container, ensure the bottom of the container aligns with the compartment frame.

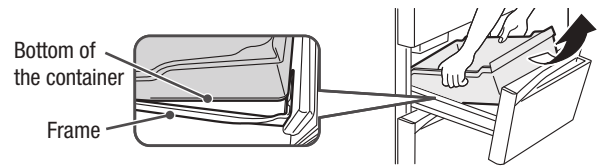

H Containers for small and large items (lower freezer compartment)

1 Open the door of the compartment, and remove the container for small items.

Caution • The container for slim items cannot be removed.

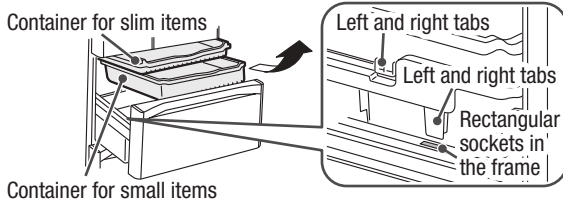

When installing the container for large items, insert the tabs on the left and right sides of the container into the rectangular sockets in the frame. Similarly, when installing the container for small items, ensure the left and right tabs of the align outside the container for large items.

• Attach the accessory case with the word "REAR" in the back side. If it is not set correctly, it may cause abnormal noise at opening and closing, as well as cause the half opening door.

2 Lift up the Lower freezer case.

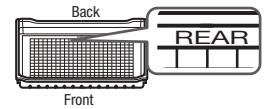
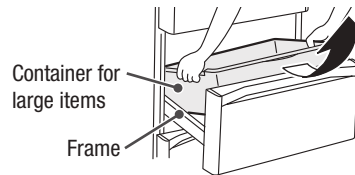

I Upper and lower containers (vegetable compartment)

1 Pull the compartment out all the way. Then, holding both sides of the compartment, lift it slightly and then slowly pull it out so that the front of the compartment rests on the floor.

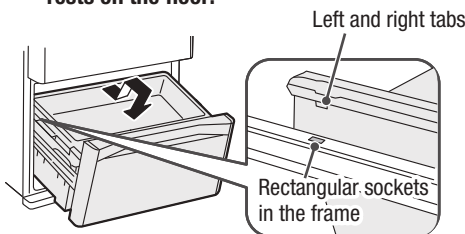

2 Lift and remove the upper container.

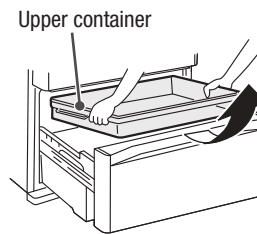

3 Remove the lower container by pulling it forward and up.

Caution

• The partition cannot be removed.

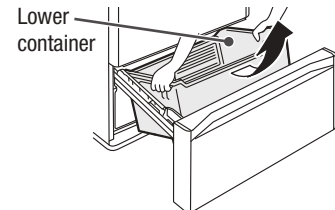

CAUTION

- When opening the compartment, be careful not to get your feet caught between the compartment and the floor.
- Water might drip from behind the lower container.

Incorrect installation of the containers or partition might cause the compartment to make strange sounds when it is opened and closed or might prevent the compartment from being closed completely.

NOTE

- Incorrect installation of the upper container might damage the container or other parts of the refrigerator.
- After installing the upper container, slide it in and out a few times to ensure it is installed correctly.

Drawer doors (ice compartment, upper and lower freezer compartments, and vegetable compartment)

Ice compartment and upper freezer compartment

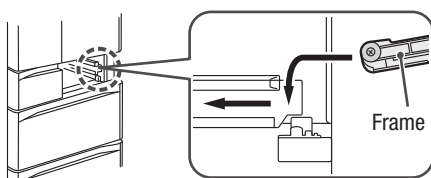

Lower freezer compartment and vegetable compartment

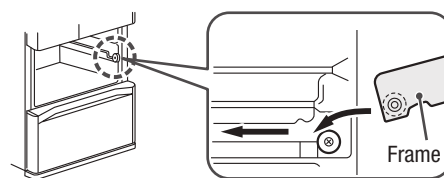



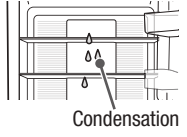

TROUBLESHOOTING

If you experience any problems with the refrigerator, first check the table below and try the suggested solution.

	Problem	Check	Solution
Start of use	The refrigerator is not very cold.	Have 24 hours passed since the refrigerator was installed?	Please wait. It might take 24 hours or more for the refrigerator to become sufficiently cold. Leave spaces between items stored in the refrigerator, and minimize how frequently you open and close the refrigerator doors. Note that, in summer or if there are many items in the refrigerator, it might take even longer than 24 hours for the refrigerator to become sufficiently cold.
	The ice maker is not working.	Have 24 hours passed since the refrigerator was installed?	Please wait. It might take 24 hours or more for the refrigerator to become cold enough to make ice. Leave spaces between items stored in the refrigerator, and minimize how frequently you open and close the refrigerator doors.
Cooling power	The refrigerator is not very cold. Ice cream or other frozen foods are soft.	Is there any food or packaging caught in the refrigerator door, preventing the door from closing completely?	Ensure that nothing is caught in the door and that the door is completely closed. In addition, pay attention to the heights of items stored in each compartment or container.
		Is the refrigerator overstuffed?	Leave spaces between items stored in the refrigerator.
		Are the containers in each compartment installed correctly?	Ensure all containers are installed correctly. → P.63
		Is the refrigerator installed correctly and under the right conditions?	Depending on where and how the refrigerator is installed, various factors might affect the refrigerator's cooling power. Ensure the refrigerator is installed correctly. → P.42
		Is "Energy Saving" mode on?	Turn "Energy Saving" mode off. → P.58
		Is the temperature set to "■"?	Change the temperature setting for the applicable compartment to "■■■" or "■■■■". → P.47, 53
		Is the ambient temperature high (for example, if it is summer)?	
		Were refrigerator doors left open for an extended period of time? Do you open and close doors frequently?	While refrigerator doors are open, the temperature inside the refrigerator gradually rises. Leaving doors open or opening doors frequently can reduce the cooling power of the refrigerator. Minimize how frequently you open and close the refrigerator doors and how long doors remain open.
Does the control panel display keep changing?	If the control panel display keeps changing, this indicates that the refrigerator is running in store-display mode. Turn store-display mode off. → P.66		
Frost or condensation	There is frost or condensation inside the refrigerator or on the frames of drawers.	Were any of the refrigerator compartment doors or drawers left open?	When closing a door or drawer, ensure nothing (food or packaging) gets caught and that the door or drawer closes all the way.
		Were refrigerator doors left open for an extended period of time? Do you open and close doors frequently?	When you open and close the refrigerator doors, moisture in the air might condense or form ice crystals and stick to the walls of the freezer compartment. Minimize how frequently you open and close the refrigerator doors and how long doors remain open. Wipe away the frost or condensation by using a dry dishcloth.
	There is condensation on the outer surface of the refrigerator.	Is the space around the refrigerator humid?	When the humidity level is high (for example, on rainy days), moisture in the air might condense onto the outer surface of the refrigerator. Wipe away the condensation with a dry dishcloth.
		Is the temperature setting set to "■■■■"?	When the temperature setting is set to "■■■■", moisture in the air might condense onto the outer surface of the refrigerator. Change the temperature setting to "■■■". Wipe away the condensation with a dry dishcloth. → P.47, 53
	There is condensation on the back of the refrigerator or on the wall.	Is the space around the refrigerator humid? Is there sufficient space between the back of the refrigerator and the wall?	Ensure there is at least 2 cm of space between the back of the refrigerator and the wall. → P.42
There is condensation inside the refrigerator compartment.	Were refrigerator doors left open for an extended period of time? Do you open and close doors frequently?	If the space around the refrigerator is humid or if you open and close the refrigerator doors frequently, moisture might condense on the interior walls of the refrigerator compartment or near the cold air vent. This does not indicate any problem in the refrigerator's functioning. Wipe away the condensation with a dry dishcloth.  Condensation	
Excessively cold	The refrigerator is too cold, causing food to freeze.	Is the temperature setting set to "■■■■"?	Change the temperature setting to "■■■". → P.47, 53
		Is the ambient temperature 5°C or lower?	When the ambient temperature is low, the refrigerator might become too cold. Change the temperature setting to "■".
		Was food placed in front of the cold air vent?	Do not place items directly in front of the cold air vent. Prevent food from freezing by covering it with a lid or in plastic wrap.

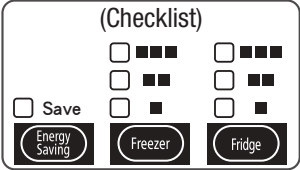
	Problem	Check	Solution
Automatic ice maker	The ice maker is not working.	Is the ice maker's "Off" indicator on?	The ice maker is turned off. Set the ice maker to "On" or "Quick". → P.50, 51
		Is the "Water" indicator on the control panel on?	The water supply tank needs to be refilled. Refill the water supply tank. → P.51
		Is the water in the water supply tank low?	If the water in the water supply tank is low, the ice maker might not work. Fill the tank to the max fill line. → P.50
		Is the water supply tank correctly set in place?	Ensure the water supply tank is pushed all the way in. → P.50
		Is any food or items other than ice stored in the ice container?	When the ice maker setting is set to "On" or "Quick", do not store any food or other items in the ice container.
	It takes a long time to make ice.	Are ice cubes accumulated in one area of the ice container?	Level the ice cubes. → P.51
		Do you open and close refrigerator doors frequently? Did you store a large amount of food in the refrigerator?	The refrigerator is not cold enough. Until the refrigerator becomes sufficiently cold, minimize how frequently you open the refrigerator doors. Leave space between items stored in the refrigerator.
		Is the ambient temperature low?	In winter, it might take 4 hours or more to make ice. Minimize how frequently you open the refrigerator doors.
		Did you just change the ice maker setting from "Off" to "On"?	If you've just changed the ice maker setting, it might take some time before the ice maker is ready to make ice. Minimize how frequently you open the refrigerator doors.
		Is there any food or packaging caught in the doors of the freezer compartment or ice compartment, preventing them from closing completely?	Ensure that nothing is caught in the doors and that the doors are completely closed.
		Is "Energy Saving" mode on?	Turn off "Energy Saving" mode. → P.58
	The ice made by the ice maker is bumpy.	_____	This is a result of water in the grooves of the ice tray freezing. It does not indicate any problems in the function of the ice maker.
	The ice cubes in the ice container become small or stuck together.	Have the ice cubes been sitting in the ice container for a long time?	If ice cubes are left unused, they will gradually grow smaller or stick together. If you can separate the ice cubes by using the ice scoop, this is not an issue.
		Do you open and close refrigerator doors frequently? Did you store a large amount of food in the refrigerator?	Minimize how frequently you open and close the refrigerator doors and how long doors remain open.
		Were the doors of the refrigerator compartment or any drawers left open for a period of time?	When you close refrigerator doors or drawers, ensure they close all the way.
	The ice maker produces small ice cubes.	Is the water in the water supply tank low?	If water in the water supply tank is low, the ice maker might produce small ice cubes. Fill the tank to the max fill line. → P.50
	The ice maker produces ice cubes that are stuck together.	_____	This is a result of water in the grooves of the ice tray freezing. It does not indicate any problems in the function of the ice maker.
There are white particles in the ice.	_____	These particles are tiny air bubbles trapped in the ice.	
	Did you use mineral water to make ice?	When the mineral content in water freezes, it might create the appearance of white particles. However, these particles are not harmful.	
I do not want to make ice.	_____	Set the ice maker to "Off". For details, see "Turning the ice maker off". → P.51	
Uneven refrigerator doors	The left and right doors of the refrigerator compartment are uneven.	Was the refrigerator installed on a level surface?	You can use the refrigerator as is. However, if you are bothered by the unevenness, adjust the left and right adjustable mounts. → P.42
		Was the refrigerator installed on a soft surface? Has one or more legs of the refrigerator sunk under the increasing weight of food stored in the refrigerator?	If the refrigerator is inclined toward one side, place the refrigerator on top of a sturdy board that is at least 1 cm thick or thicker.

TROUBLESHOOTING (continued)

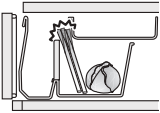
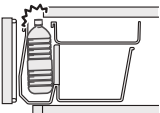
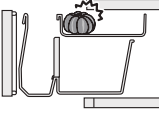
	Problem	Check	Solution
Blinking indicators on the control panel	Three or more indicators of the refrigerator or "Save" freezer compartment are blinking.	"Save", Check each of the six "Fridge" and "Freezer" indicators to see if they are blinking or off.	In the provided checklist, mark (☑) the indicators that are blinking. Then, contact a customer service center and use the checklist to inform personnel of the issue. → P.72 
	The ice maker's "On" indicator is blinking.	Is there anything in the ice container other than ice cubes made by the ice maker?	The ice tray might have come in contact with food or other items in the ice container. Empty the ice container, and then clean the ice maker. Do not put food or ice not made by the ice maker, in the ice container. → P.61
	The vacuum compartment's "On" indicator is blinking.	Was your refrigerator just checked by service engineer?	The refrigerator might be running in maintenance mode. Maintenance mode will turn off after about 15 minutes. This mode does not affect the refrigerator's function.
	Quick On Off All indicator lamps blink	Did you touch the  button for 5 seconds or more?	If you touched the "Ice Maker" button for 5 seconds or more, the refrigerator might be in the process of cleaning the ice maker. The indicators should stop blinking in about 4 minutes. Do not open the refrigerator doors while indicators are still blinking.
	All indicators are blinking.	Are any of the doors open? Is there any food or packaging caught in the doors?	If any doors are open, close them. If anything is caught in the doors, remove it and then close the doors all the way.
Vegetable compartment	There is condensation inside the vegetable compartment.	Did you put a lot of vegetables high in water content in the vegetable compartment?	This means that the refrigerator is operating in the sales displaying mode. Make the sales displaying mode off. In order to prevent the refrigerator is cooled at operating in the sales displaying mode. Open the doors of the refrigerator compartment and the lower freezer compartment. Touch the  and start it up. Then touch the  not less than 10 seconds until the beep sounds turns on twice. Light the all indication lamps for some seconds to show that the sales displaying mode is off. The refrigerator starts to be cooled. Close the doors of refrigerator compartment and freezer compartment.
		Is the moisture-retention unit blocked (for example, by food in containers or bags)?	If the moisture-retention unit is blocked, moisture is more likely to condense. Move any item that is blocking the moisture-retention unit, and wipe away the condensation with a dry dishcloth.
	The vegetable compartment doesn't close. When I open the vegetable compartment, the upper container won't return to its locking position.	Is there any food or packaging caught between the upper and lower containers? 	Ensure nothing is caught between the containers.
		Is any item (such as food or bottled drinks) in contact with the handle of the upper container? 	Store food and other items in such a way that they do not come in contact with the handle.
		Is there any food or packaging caught between the upper container? 	Ensure nothing is caught between the upper container and the moisture-retention cover. In addition, don't close the door of the refrigerator with the status that a food is contacting the ceiling of the vegetable compartment.

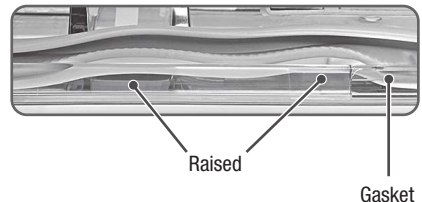
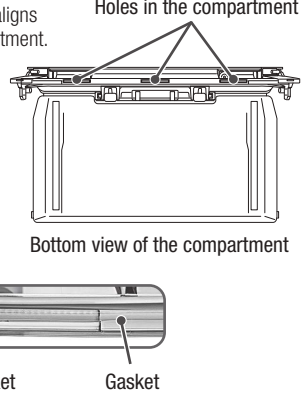
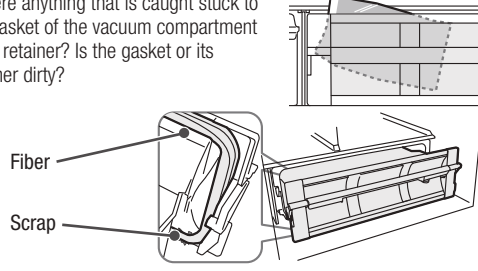
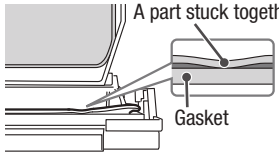
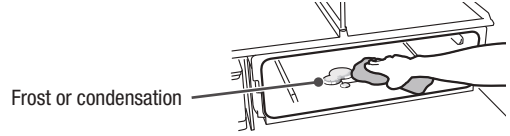

Problem	Check	Solution
<p>There is no hissing sound when I open the vacuum compartment.</p> 	<p>Is the "Vacuum" setting set to "Off"?</p>	<p>Change the setting to " On". → P.49</p>
	<p>Is the handle partially raised?</p>	<p>Press the handle down firmly to lock the vacuum compartment.</p>
	<p>Did you press the handle down firmly to lock the vacuum compartment?</p>	<p>If the handle is not secure, a vacuum state cannot be achieved. Push the vacuum compartment all the way in, and then press the handle down firmly to lock the compartment.</p>
	<p>Is the gasket of the vacuum compartment loose or misaligned?</p> 	<p>Install the vacuum compartment so that the tabs on the gasket aligns with the holes in the compartment. Ensure the gasket is securely in its retainer, with no raised parts.</p> 
	<p>Is there anything that is caught stuck to the gasket of the vacuum compartment or its retainer? Is the gasket or its retainer dirty?</p> 	<p>Remove any packaging material of foods or other things which are caught in. If the gasket is dirty, clean it. → P.60</p>
	<p>Is any part of the gasket stuck together?</p> 	<p>If a part of the gasket is stuck together, the vacuum compartment will not be able to maintain a vacuum state. If there is a part stuck together, peel such part off. Since it is difficult to see the left and right side faces and the bottom, such part shall be confirmed with removing the vacuum compartment. → P.62 → P.60 If the gasket is dirty, clean it.</p>
<p>Did you just open the vacuum compartment?</p>	<p>After you close the refrigerator doors and the vacuum pump starts up, it takes about 3 to 4 minutes to achieve a vacuum state. Wait at least 4 minutes before opening the vacuum compartment.</p>	
<p>I am not sure if the vacuum function is working.</p>	<p>When you open the vacuum compartment, do you hear a sound?</p>	<p>If the vacuum function is working properly, when you open the vacuum compartment, you should hear a hissing sound as air enters the compartment.</p>
<p>I cannot lock the handle.</p>	<p>Is there any food or packaging caught in the vacuum compartment gasket or in the vacuum compartment receptacle?</p>	<p>Ensure nothing is caught in the gasket or in the receptacle.</p>
<p>The vacuum compartment vibrates and emits a humming sound.</p>	<p>Is the vacuum compartment installed correctly?</p>	<p>Install the vacuum compartment in accordance with the procedure described in "HOW TO REMOVE/INSTALL PARTS". → P.62</p>
<p>The vacuum compartment vibrates and emits a humming sound.</p>	<p>Is there any food or packaging caught in the vacuum compartment receptacle? Is the vacuum compartment gasket dirty? Did you press the handle down firmly to lock the vacuum compartment?</p>	<p>This sound is made by the vacuum pump when it is running. If you are bothered by the sound (for example, at night), you can stop the pump from running by changing the "Vacuum" setting to "Off". → P.49</p>
<p>The vacuum compartment vibrates and emits a humming sound.</p>	<p>Is there any food or packaging caught in the vacuum compartment receptacle? Is the vacuum compartment gasket dirty? Did you press the handle down firmly to lock the vacuum compartment?</p>	<p>The refrigerator regularly vibrates and emits sounds. Ensure nothing is caught in the vacuum compartment receptacle and that the gasket is clean. → P.60 Press the handle down firmly to lock the vacuum compartment.</p>
<p>There is frost or condensation inside the vacuum compartment or around the vacuum compartment receptacle.</p>	<p>Did you put food high in water content in the vacuum compartment?</p> 	<p>The vacuum compartment is tightly sealed. As such, the water content in foods and moisture in the air might form frost or condensation inside the compartment. If this happens, wet a dishcloth in warm water and wipe away the frost or condensation. In addition, we recommend that you wrap foods high in water content before storing them in this compartment.</p>

TROUBLESHOOTING (continued)

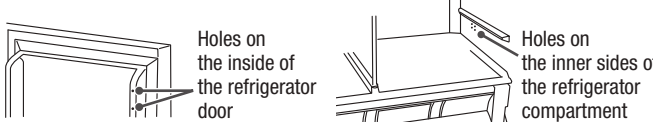
	Problem	Check	Solution
Strange odors	There is a plastic odor.	_____	This does not indicate any problem in the refrigerator's function. The refrigerator has many plastic parts. As the refrigerator get colder, the plastic odor should gradually dissipate.
	The ice cubes smell.	Is the water supply tank or water filter dirty? Have the ice cubes been sitting in the ice container for a long time?	To prevent the accumulation of viscous liquid and the formation of slime or water stains, wash the tank and filter regularly. → P.60, 61
		_____	If you used tap water to make ice, chlorine in the tap water might have condensed, causing a strong odor of chlorine.
	The inside of the refrigerator smells.	Did you store food that has a strong odor in the refrigerator?	The deodorizing function does not eliminate all odors. Cover foods that have strong odors, with a lid or by using plastic wrap.
Overheating of the refrigerator	The sides of the refrigerator are hot. I feel hot air coming from under the refrigerator.	_____	The refrigerator might become hot as it lets out the heat generated during operation. Immediately after installation or in summer, the temperature of the refrigerator's external surfaces might rise to 50°C to 60°C. This does not indicate any problem in the refrigerator's function or safety. However, try to avoid touching the refrigerator's sides.
Strange sounds	The refrigerator is making loud sounds.	Is the floor uneven?	Place the refrigerator on top of a sturdy board that is at least 1 cm thick or thicker. → P.42
		Is the refrigerator touching any walls or other appliances/furniture?	Leave space around the refrigerator.
		Is the refrigerator sufficiently cold?	In the following cases, the compressor runs at a high speed, creating loud sounds: <ul style="list-style-type: none"> • If the refrigerator is not sufficiently cold (for example, right after purchase or when you begin using it) • If you open and close the refrigerator doors frequently • If the ambient temperature is high
		Is the ice maker set to "Quick" "Quick Freeze"?	When the ice maker is set to "Quick" "Quick Freeze", the compressor and fan motor run at high speeds, creating loud sounds.
	The refrigerator continues to emit sounds for a long time.	_____	To save energy, the compressor runs at a lower speed, accounting for the longer sound.
	The sound of the refrigerator is getting louder.	_____	The refrigerator changes its operating power based on changes in temperatures inside its compartments. As a result, sometimes, the sound of the refrigerator might become louder.
The refrigerator is making other sounds, such as those described on the right.	Trickling, tapping, bubbling, or sizzling		This does not indicate a problem in the refrigerator's function. (These sounds might be created by flowing refrigerant, water generated by the defrosting function, and water evaporating.)
	Creaking, squeaking, or knocking		This does not indicate a problem in the refrigerator's function. These sounds might be created when changes in the refrigerator's temperature or changes in the pressure of the vacuum compartment cause various refrigerator parts to creak.
	Rattling, buzzing, or humming (after the refrigerator doors are closed)		This does not indicate a problem in the refrigerator's function. These sounds might be created when refrigerator's temperature control mechanism or vacuum pump is running.
	Whirring, clattering, gurgling, and other sounds made by the ice maker		This does not indicate a problem in the refrigerator's function. These sounds might be created when ice cubes fall from the ice tray or when the tray is filled with water. When you do not need to make ice, touch the  button to change the ice maker setting to "Off". → P.51
	Rattling, sizzling, and other occasional sounds		This does not indicate a problem in the refrigerator's function. (These sounds might be created when the refrigerator starts or stops its cooling process.)

	Problem	Check	Solution
Other	I felt an electric shock when I touched the refrigerator.	_____	You might feel static shock when you touch the refrigerator, but this does not indicate any problems in its functions or any safety issues.
	The refrigerator is interfering with the sound/display of my TV/radio.	_____	This refrigerator emits electromagnetic radiation. Do not install the refrigerator near TV sets, radios, or interphones. Plug the refrigerator into an outlet that is not in close proximity to any antennas or wiring.
	Some of the plastic parts appear to have thin scratch lines.	_____	Those lines are caused by the flow liquid resin when the plastic part was molded. They might be particularly conspicuous in transparent parts, but these lines not indicate a problem in the strength of plastic parts and have not been known to lead to cracking.
	The surfaces of the refrigerator (such as the doors, the sides, or the top of the refrigerator) seem slightly warped.	_____	The slight warping of surfaces might occur when the refrigerator is manufactured. Depending on lighting and other factors, the warping might be more conspicuous. However, this is normal and does not indicate a problem in the refrigerator's function.
	There are small holes on the inside of the refrigerator doors and on the inner sides of the refrigerator compartment.	_____	<p>These holes are required for the manufacturing process. They are not defects in the refrigerator.</p>  <p>Note: Depending on the refrigerator model, these holes might be covered with adhesive stickers. Do not remove these stickers.</p>
	There was a power outage.	_____	Until power is restored, minimize the number of times you open the refrigerator doors and do not store any items that are not already in the refrigerator. When power is restored, check and, if necessary, reconfigure the control panel settings.
	I won't be using the refrigerator for an extended period of time.	_____	Remove all stored items from the refrigerator. Unplug the refrigerator, and then clean the ice maker and the inside of the refrigerator. Leave all refrigerator compartments open for about 2 to 3 days, so that each compartment dries thoroughly. → P.59-61
	I want to defrost the refrigerator.	_____	You do not need to defrost the refrigerator, because it has self-defrosting function. Water from the thawed frost collects in a tray, where it then evaporates.
	I want to move or transport my refrigerator.	_____	Refer to the procedure "Moving or transporting the refrigerator" below. → P.70
	The glass surface of a refrigerator door or a glass shelf is broken.	_____	Do not touch the broken glass. Contact your vendor as soon as possible to request repair.
	When I close one refrigerator door, another opens.	_____	Do not close doors forcefully. The various compartments are interconnected by airways for cold air. As such, if you forcefully close one refrigerator door, the air pressure might cause another door to open.
	If I close a refrigerator door and then try to open it immediately afterward, the door feels heavy.	_____	Do not leave the refrigerator doors open for an extended period of time. If you do, air that enters the refrigerator will cool suddenly creating a temporary mass of low-pressure air. To prevent this problem, do not leave doors open for an extended period of time. Minimize the amount of time for which doors are open.
	I am concerned about the loud vibration noise, or the discoloration or staining of the wall behind the refrigerator caused by high humidity.	_____	Ensure to leave at least 2 cm of space between the refrigerator and the wall behind it. → P.42
	A fly or other insect enters the refrigerator	Are there many flies near the refrigerator?	_____
Does the refrigerator contain food with strong odors?		_____	Cover all food with lids or plastic wrap, so that flies are not attracted by the odor.
Were refrigerator doors left open for an extended period of time?		_____	Keep the refrigerator doors closed as much as possible.

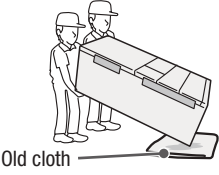
Moving or transporting the refrigerator

- | | | | | |
|----------|--|--|---|---|
| 1 | Remove all items (including ice) stored in the refrigerator. | 7 | Place a piece of cloth below the drainage outlet*. Tilt the refrigerator backward to drain any water left in the refrigerator. |  <p>Old cloth</p> <p>* Located at the lower part of the back of the refrigerator</p> |
| 2 | Dispose of any water in the water supply tank or ice container.
Remove the water supply tank, and clean the ice maker. → P.61 | 8 | Grasp the handles for moving the refrigerator, to move it. You will need at least two people to move it. | |
| 3 | Unplug the power cord.
You can wait to unplug the power cord until right before you move the refrigerator. |  <p>When transporting the refrigerator, stand the refrigerator upright. If you lay it horizontally, it might damage the refrigerator.</p> | | |
| 4 | Remove the leg covers and raise the adjustable mounts. → P.42 | | | 9 |
| 5 | Use tape to secure the doors and the power cord. | | | |
| 6 | Lay a protective sheet or cloth along the path where the refrigerator will be moved.
This is to prevent the floor from being scratched and to protect it from any water that might drip from the refrigerator. | | | |

AVAILABLE PARTS

■ When ordering the following part, be sure to go through an authorized dealer.

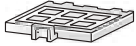
Problem	Part name	Refrigerator model	Part model	
The ice cubes smell. ● The water filter might be old or dirty. (As a guide, the filter should be replaced every 3 or 4 years.)	Water filter for the automatic ice maker	All models	RJK-30	

有關碳氫化合物的冰箱／可容納的食品重量

NOTES ON NON-CFC REFRIGERATORS/GUIDE ON TOTAL STORABLE WEIGHT

有關碳氫化合物的冰箱 Notes on non-CFC refrigerators

- 本冰箱所使用冷媒及其他斷熱材料皆無使用氟氯化碳，而是使用碳氫化合物。碳氫化合物不會破壞地球臭氧層，對地球溫室效應的影響非常小，屬於環保物質。
- 碳氫化合物為可燃型物質。冷媒密封於冷媒迴路管中，在一般的使用情況下應該不會發生外洩。但萬一有冷媒管線損壞的情況發生，請遠離火源及避免使用電器用品，將門窗打開以利空氣流通。之後，請立即與經銷商或日立技術中心聯絡。
- This refrigerator uses hydrocarbons, instead of chlorofluorocarbons (CFCs), in its refrigerant and insulation materials. Hydrocarbons do not damage the ozone layer, have minimal impact on global warming, and are thus considered comparatively environment-friendly.
- Note that hydrocarbons are flammable. The refrigerant is sealed in the cooling circuit and should not leak under normal operation. If the cooling circuit is damaged, open a window to ventilate the room, and avoid using fire and electrical appliances. Keep your distance from the refrigerator, and contact a customer service center to request repair.

可容納的食品重量 Guide on total storable weight

可容納於層架或收納盒內的食物重量如下：

Refer to the following table as a guide on the total weight of food that can be stored on each shelf or in each container.

	零件名稱 Name of parts	R-HWS480K 型號 R-HWS480K type
冷藏室 Refrigerator compartment	可調式層架上段 Upper height-adjustable shelf	15.5 kg
	可調式層架中段 Middle height-adjustable shelf	15.5 kg
	可調式層架下段，固定層架 Lower height-adjustable shelf and fixed shelf	15.5 kg
	真空冰溫室上方的層架 Shelf above the vacuum compartment	8.0 kg
	真空冰溫室盒 Vacuum compartment	3.0 kg
	冰箱門置物架合計 Total for shelves door	21.5 kg
製冰室 Ice compartment	儲冰盒 → P.17 Ice container → P.51	
上層冷凍室 Upper freezer compartment	上層冷凍盒 Upper freezer container	4.0 kg
下層冷凍室 Lower freezer compartment	上層滑動盒 Container for slim items	4.0 kg
	中層滑動盒 Container for small items	5.0 kg
	下層冷凍盒 Container for large items	12.0 kg
蔬果保鮮室 Vegetable compartment	上層滑動盒 Upper container	4.5 kg
	下層置物盒 Lower container	14.5 kg

關於廢棄之重要警告 Important notes on disposal

隔熱材料中含有環戊烷 (Cyclopentane)。

當要處理隔熱材料中之氣體時，必須依照特殊的廢棄處理程序。

要廢棄本產品時，為了不會對環境造成不良影響，請詢問當地的相關機關。

The insulation material of this refrigerator uses cyclopentane and other gases that require special procedures for safe disposal. To dispose of this refrigerator, please contact your local environmental protection agency (or some other relevant agency), and inquire about safe disposal procedures.

AFTER-SALES SERVICE

關於售後服務

Please contact one of the following Hitachi customer service centers if the power cord is damaged or maintenance is required.

If the refrigerator malfunctions, immediately unplug the power cord, and contact a customer service center to request repair.

電源線受損或需要維修時，請直接洽詢下列日立服務中心。

使用中出現異常現象時，請立即拔掉電源插頭以及聯絡售後服務中心以進行修理。

- Hong Kong
Arcelik Hitachi Home Appliances Sales Hong Kong Limited
18/F., Ever Gain Centre, 28 On Muk Street, Shatin, N.T.,
Hong Kong, China
Tel: +852-2753-5386
Fax: +852-2753-0993
- Singapore
Arcelik Hitachi Home Appliances Sales (Singapore) Pte. Ltd.
438A Alexandra Road, #01-01/02/03, Alexandra Technopark,
Singapore 119967
Tel: +65-6536-2520
Fax: +65-6536-2521
- 香港
阿奇立克日立家電（香港）有限公司
中國 香港 新界 沙田 安睦街 28 號 永得利中心 18 樓
Tel: +852-2753-5386
Fax: +852-2753-0993



R-HWS480K 型號 ①
R-HWS480K Type